

- **Manual de instrucciones.**
- **Manual de instruções.**
- **Mode d'emploi.**
- **Operating instructions.**
- **Bedienungsanleitung.**
- **Manuale di istruzioni.**

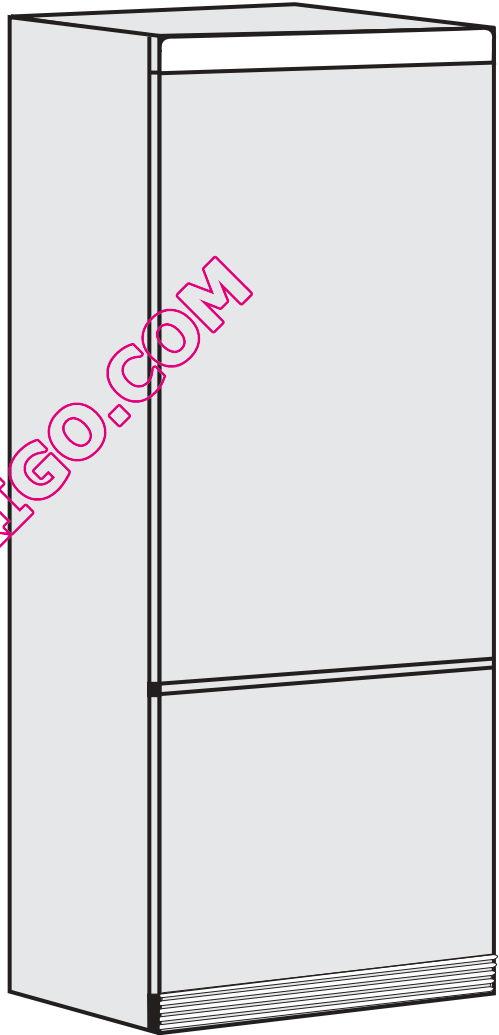

QUELFRIGO.COM

# INDICE

	Pag.
Instalación.....	2
Descripción general .....	3
Puesta en funcionamiento .....	4
Utilización del refrigerador .....	5
Utilización del congelador .....	7
Limpieza y mantenimiento .....	11
Cambio de sentido de apertura de puertas .....	12
Panelación (Sólo modelos P/PB).....	14
Problemas de funcionamiento .....	15
Especificaciones .....	16

## ADVERTENCIA

Si su antiguo frigorífico dispone de pestillos de cierre automático o manual, **NO OLVIDE DESTRUIR O INUTILIZAR EL SISTEMA DE CIERRE** antes de echarlo a la chatarra. Con ello evitará que los niños al jugar puedan quedar encerrados dentro. **NO DAÑE LAS TUBERIAS** y evitará el escape incontrolado de refrigerante a la atmósfera.

## SEGURIDAD

- El modelo de frigorífico que usted ha adquirido se comercializa con los refrigerantes R600a ó R134a. Puede verificarlo mirando en la placa de características, y si su frigorífico utiliza R600a tenga en cuenta que:
  - Este refrigerante no deteriora al medio ambiente.
  - Es inflamable, por lo que asegúrese de que el circuito frigorífico está en perfectas condiciones. Si ha sufrido algún daño, consultar con el distribuidor antes de conectar.
- Este aparato únicamente puede ser reparado por el servicio de asistencia técnica y utilizando repuestos originales.
- No utilice elementos con fuego ni aparatos eléctricos dentro del aparato.
- No deje que los niños jueguen con el aparato.
- Evite que el cable esté en contacto con el compresor.
- Evite que el cable quede atrapado debajo del aparato.
- Para evitar daños al medio ambiente y recuperar materiales, utilice el servicio de recogida municipal.



# INSTALACION

## RECOMENDACIONES

Permitir la circulación de aire por la parte trasera del frigorífico.

No taponar la rejilla delantera ni el techo del frigorífico con ningún objeto. Si se instala un armario encima, tendrá un hueco para que el aire circule.

La clase climática de su frigorífico se encuentra indicada en la placa de características. Esta determina el rango de temperaturas ambiente para el que está diseñada la unidad frigorífica y en las cuales se asegura el correcto funcionamiento del aparato. Cuando se indican las dos clases, se asegura el correcto funcionamiento en las condiciones de cada una de ellas.

Clase	Temperaturas ambiente
N	16° hasta 32°
ST	18° hasta 38°
T	18° hasta 43°

Evitar en lo posible la proximidad de fuentes de calor.

Si necesita tumbar el frigorífico para desembalarlo o cambiar el sentido de giro de las puertas, **SOLO SE PUEDE TUMBAR SOBRE LA PARTE TRASERA.**



NOTA: Las bisagras de las puertas están en el lado derecho. Si esta disposición es incómoda para usted, es posible cambiar de lado las bisagras. En el anexo CAMBIO DE SENTIDO DE APERTURA DE PUERTAS están las instrucciones.

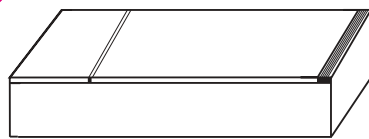

Regulando los pies de nivelación comprobar que el frigorífico queda bien apoyado en el suelo (sin cojear) y bien nivelado (no ladeado). **IMPORTANTE**

Este frigorífico funciona a 220/230v. Si Vd. dispone de una tensión diferente en su hogar, debe utilizar un transformador de potencia no inferior a 500W. Utilice un enchufe con TOMA DE TIERRA.

NOTA: El fabricante declina toda responsabilidad en caso de que no se sigan estas recomendaciones.

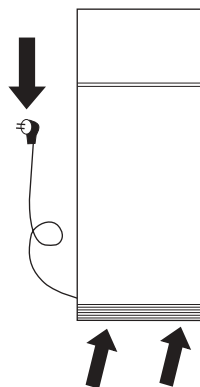

## ATENCION ANTES DE CONECTAR

1.- Limpiar el interior del frigorífico.



2.- Para un correcto funcionamiento, esperar 2 horas antes de conectar.



3.- Conectar.



# DESCRIPCION GENERAL

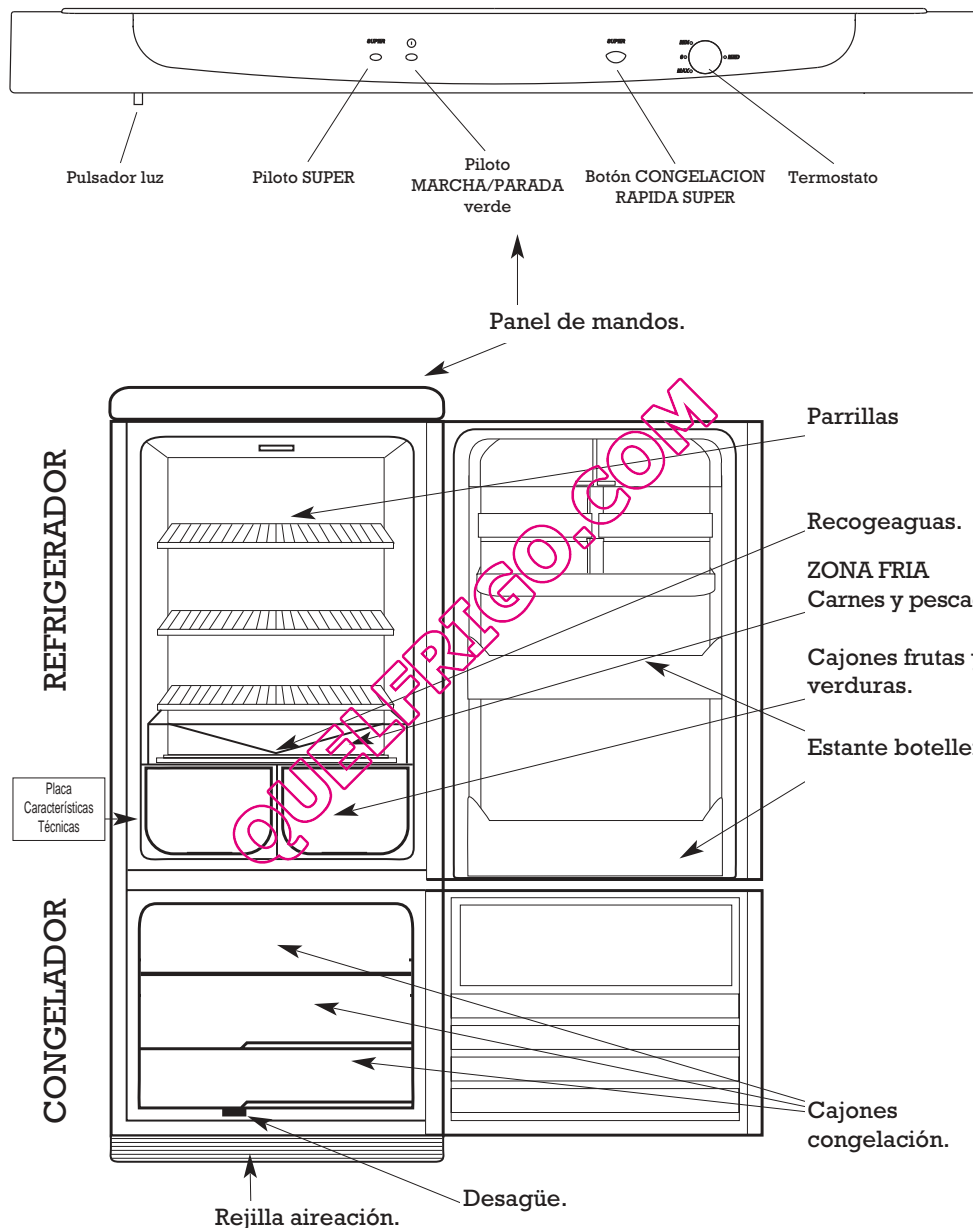

# PUESTA EN FUNCIONAMIENTO

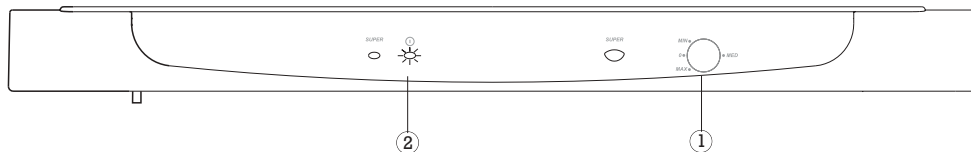

- 1** Girando el mando del termostato ① en sentido de las agujas del reloj, el piloto ② se encenderá y el frigorífico se pondrá en marcha.

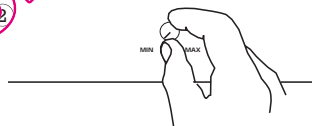

- 2** Girando el mando termostato, seleccione más frío (MAX) o menos frío (MIN) en el refrigerador. Inicialmente se recomienda llevar a una posición intermedia.

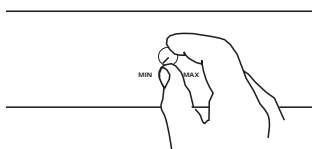

# UTILIZACION DEL REFRIGERADOR

## ALIMENTOS

ZONA MENOS FRIA

ZONA INTERMEDIA

ZONA MAS FRIA



## ATENCIÓN

- Girando el mando termostato se puede seleccionar más o menos frío en el refrigerador.
- Hay que tener en cuenta que la temperatura no es totalmente uniforme en todo el recinto, por lo que hay zonas adecuadas para cada tipo de alimento (según figura).
- La temperatura en el refrigerador puede verse afectada por la temperatura ambiente, la ubicación del aparato y la frecuencia de apertura de la puerta.
- No introducir en el refrigerador alimentos calientes o líquidos sin taponar.
- No introducir NUNCA líquidos volátiles, inflamables o explosivos, como disolventes, alcoholes, acetona o gasolina. Hay riesgo de explosión.
- Las carnes y pescados es conveniente envolverlos para evitar olores.

## SISTEMA MULTIFRESH

Si su frigorífico dispone de un compartimento Multifresh:

- Este garantiza una **conservación ideal** para alimentos frescos como carnes y pescados y también para hortalizas. Ello le permitirá conservar estos alimentos durante más tiempo sin necesidad de congelarlos.
- En este recinto se dispondrán de las **temperaturas más frías** del refrigerador, siendo además la zona menos influenciada ante las frecuentes aperturas.
- Para mantener **carnes y pescados**, se recomienda seleccionar una temperatura intermedia en el refrigerador.
- Para conseguir una **mayor capacidad** en el refrigerador retire la bandeja superior del recinto y la tapa. Almacenando directamente sobre la cubeta. En este caso el recinto pierde las propiedades indicadas.



# UTILIZACION DEL REFRIGERADOR

## DESHIELO

El sistema de deshielo del refrigerador funciona automáticamente, por tanto no necesita ninguna intervención del usuario.

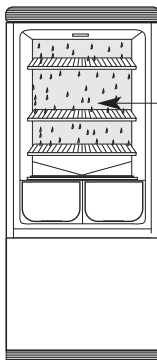

La pared del fondo del refrigerador estará habitualmente llena de gotitas de agua o hielo. Esto es totalmente NORMAL y forma parte del proceso automático de deshielo.

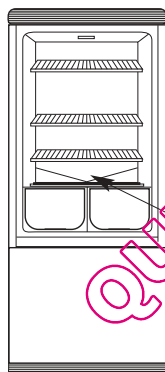

Si el canal recogeaguas se atasca debido a la suciedad o algún objeto que lo obstruya, límpielo . Evitará con ello el derrame de agua fuera del canal recogeaguas.

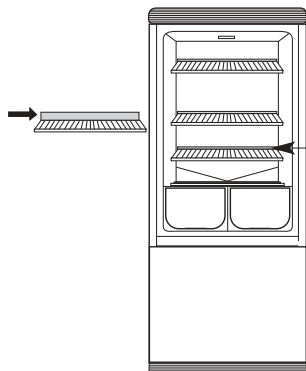

Procure que los alimentos no toquen la pared del fondo. Para ello las parrillas disponen de un tope que no se debe sobrepasar.



# UTILIZACION DEL CONGELADOR

## CONGELACION ALIMENTOS FRESCOS

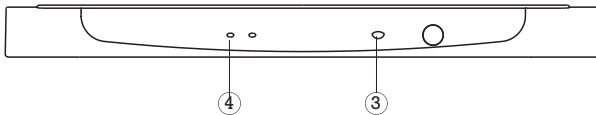

**1** Introduzca los alimentos a congelar en el congelador.

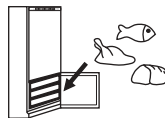

**2** Pulse el botón de congelación rápida ③ (SUPER). El piloto ④ se encenderá.



**3** 24 horas más tarde, vuelva a pulsar el botón ③ desconectándolo. El piloto ④ se apagará. Sus alimentos estarán perfectamente congelados.

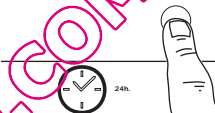

### NOTA

- El congelador de este frigorífico tiene categoría de **★\*\*\*** 4 estrellas en cualquiera de sus cestos, y es capaz de congelar en 24 horas los kgs. indicados en la placa de características.
- Si Vd. desea congelar de una vez una cantidad considerable de alimentos, obtendrá una mejor congelación pulsando el botón de congelación rápida 24 horas antes, consiguiendo de esta manera el mantenimiento de las temperaturas adecuadas en el refrigerador, evitando que se enfríe en exceso.

### CONSEJOS

- Envuelva los productos a congelar en papel aluminio o recipientes herméticos.
- Prepare los alimentos en raciones consumibles de una sola vez.
- Nunca congele por segunda vez un alimento descongelado.
- Coloque una etiqueta en el envoltorio indicando el contenido y la fecha de congelación.
- No ponga en contacto directo los alimentos a congelar con los ya congelados.
- No almacene en el congelador bebidas gaseosas.
- Los helados no deben consumirse demasiado fríos.

# UTILIZACION DEL CONGELADOR

## CONSERVACION DE ALIMENTOS CONGELADOS

### CONSEJOS

- Cuando adquiera alimentos congelados en el comercio, procure que transcurra el menor tiempo posible hasta su introducción en el congelador.
- Preste atención al tiempo de conservación marcado en los envases de los productos congelados, teniendo en cuenta que este congelador es de categoría 4 estrellas. \* \*\*\*
- Para los alimentos congelados por usted, consulte la tabla de tiempos de conservación

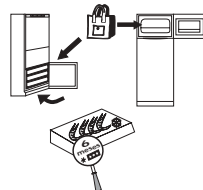

### TIEMPOS DE CONSERVACION

TIPO DE ALIMENTO	Número Meses
<b>PESCADOS Y MARISCOS</b>	
Langosta-Crustáceos	3
Gambas-Langostinos	3
Merluza	2
Pescados grasos	3/4
Trucha	2/3
Salmón	2/3
Lenguado	3
Rodaballo	2/3
<b>CARNE</b>	
Vacuno mayor	10/12
Cordero	6/8
Ternera	9
Cerdo	6
Filetes/Chuletas	4
Hígado/Riñones	10
Seso/Lengua	2
Carne picada, Salchichas	2
Conejo	5/7
<b>AVES Y CAZA</b>	
Gallinas-Pollos	10
Pavo- (troceado)	7
Pato, Ganso, Oca	5
Liebre	6
Perdiz-Codorniz	8
Faisán	7/8
Caza Mayor	10
<b>PLATOS PREPARADOS</b>	
Salsa de tomate	3
Caldo de Carne	3
Asados: buey, ternera, pollo, cerdo	2/3
Menestra de verduras	3
Carne cocida, Estofado	3
Hamburguesas	2
Pimientos rellenos	2
Espinacas	2
Judías verdes y salteadas	2
Tartas empanadas, etc.	5/6
Macedonia de frutas	3
Sandwiches	6

TIPO DE ALIMENTO	Número Meses
<b>HORTALIZAS</b>	
Acelgas	12
Alcachofas	12
Zanahorias	12
Coliflor	6/8
Coles de Bruselas	6
Espárragos	12
Berza	6/8
Judías	12
Setas	6
Perejil	12
Pimientos	12
Espinacas	12
Habas	12
<b>FRUTAS</b>	
Albaricoque	8
Cerezas, ciruelas, frambuesas, grosellas, moras	10
Melocotón	10/12
Fresas	12
Compotas (manzanas, peras)	10
Uva	10/12
Zumos fruta	10
Piña	10/12
<b>PAN Y PASTERIA</b>	
Bizcochos-Tartas	6
Tarta hojalde	1
Masa de pastelería	3
Pan y bollería	2
<b>HUEVOS, LECHE Y DERIVADOS</b>	
Huevos (quitada la cáscara)	6
Leche homogeneizada (envase de cartón)	3
Mantequilla	6
Quesos (pequeñas porciones)	6/8
Nata fresca	3

# UTILIZACION DEL CONGELADOR

## DESCONGELACION DE ALIMENTOS

No todos los alimentos deben ser descongelados de la misma forma.

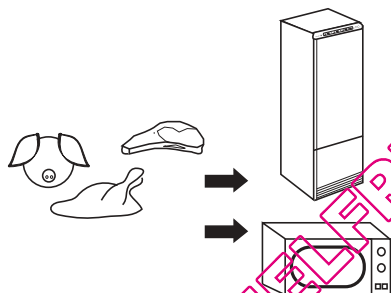
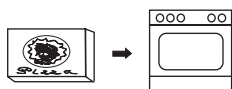
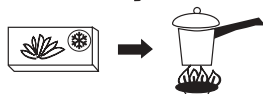

Si adquirió el alimento congelado en el comercio, siga las instrucciones del envase.

Las verduras deben cocinarse directamente.

En general, los alimentos preparados o precocinados pueden cocinarse directamente.

Carnes y pescados han de descongelarse lentamente en el refrigerador durante varias horas. Si usted dispone de horno microondas, podrá acelerar el descongelo en gran medida.

## PRODUCCION DE CUBITOS DE HIELO

- 1** Llene hasta las tres cuartas partes de agua las bandejas que encontrará en el interior del congelador.



- 2** Introduzca las bandejas en el congelador, preferiblemente en la parte superior.



- 3** Una vez congelada el agua, puede desmoldear los cubitos retorciendo ligeramente las bandejas.

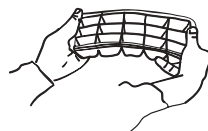

# UTILIZACION DEL CONGELADOR

## DESHIELO Y LIMPIEZA

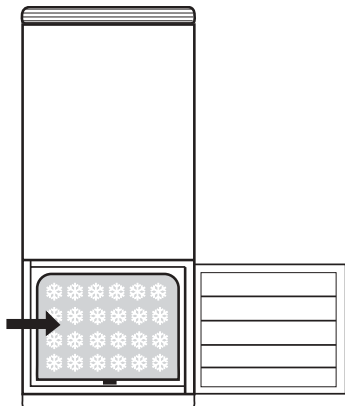

Con el tiempo, en las paredes del congelador se va formando una capa de escarcha o hielo. Esto provocará un mayor consumo de energía en su frigorífico. Para evitarlo, hay que eliminar esta capa de hielo, al menos 2 veces al año.

- 1** Girando el mando del termostato en sentido contrario a las agujas del reloj, se apagará el piloto y el frigorífico quedará desconectado.



- 2** Retire los alimentos congelados, envuélvalos en papel absorbente (periódico o similar) e introduzcalos en el refrigerador, ya que una elevación excesiva de la temperatura de los alimentos podría disminuir su duración.

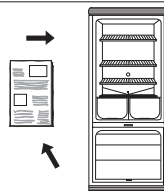

- 3** Deje la puerta abierta y extraiga el desagüe del congelador que encontrará en uno de los cestones. Coloque debajo cualquiera de los cestones, excepto el inferior, para recoger el agua de deshielo.

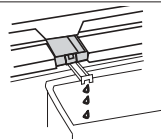

- 4** Puede ayudar a eliminar el hielo mediante una paleta o introduciendo un recipiente con agua caliente. No utilice objetos afilados ni aparatos de calentamiento eléctricos.

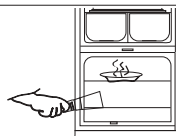

- 5** Seque bien el interior.

- 6** Gire el mando del termostato en el sentido de las agujas del reloj, se encenderá el piloto y el frigorífico quedará conectado.

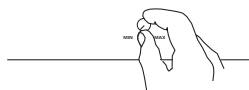

- 7** 2 horas más tarde puede volver a introducir los alimentos congelados en el congelador.



# LIMPIEZA Y MANTENIMIENTO

## LIMPIEZA

### CONSEJOS

Para la limpieza del interior el frigorífico debe estar desconectado.

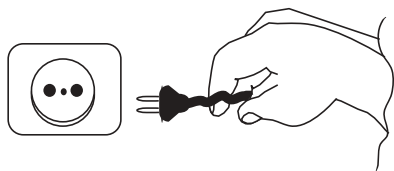

No utilice productos abrasivos disolventes, limpiadores de metales o detergentes no diluidos.



Evite derramar agua sobre el techo o limpiarlo con trapos mojados en exceso. Podría dañar el frigorífico.

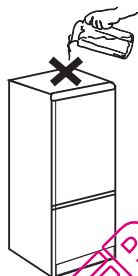

Es conveniente limpiar una vez al año con una aspiradora la rejilla de la parte trasera del frigorífico. La suciedad perjudica el funcionamiento y aumenta el consumo de energía eléctrica.

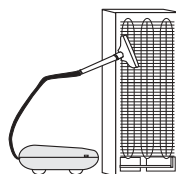

## PARADA TEMPORAL DEL FRIGORIFICO

- Desconecte el frigorífico.
- Retire los alimentos, limpie y seque el interior.
- Deje la puerta abierta para evitar la formación de malos olores.
- Haga lo mismo en caso de corte de corriente prolongado o fallo del frigorífico.

## CAMBIO DE LAMPARA

1- Desconectar el frigorífico.

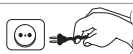

2- Extraer la lámpara estropeada y reponerla con otra del mismo tipo



220 v  
15 w max.

# CAMBIO DE SENTIDO DE APERTURA DE PUERTAS

- 1 Extraiga la carcasa del panel de mandos introduciendo la punta de un destornillador en las ranuras de amarre, haciendo palanca hasta liberar las pestañas.

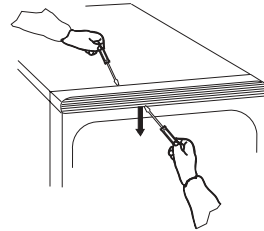

- 2 Extraiga la bisagra superior soltando previamente el tornillo de sujeción. Sujete la puerta superior con ambas manos y retírela del frigorífico.

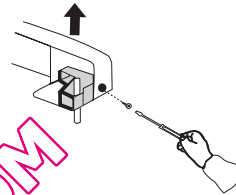

- 3 Extraiga la bisagra intermedia retirando la plaquita protectora que oculta los tornillos y soltándolos, sujete la puerta inferior con ambas manos y retírela del frigorífico.

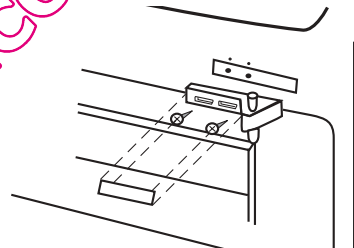

- 4 Extraiga el zócalo inferior tal como se indica en la figura. Seguidamente, rasgue la parte izquierda marcada del zócalo para alojar la bisagra inferior según figura.

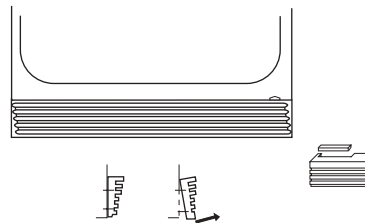

- 5 Extraiga la bisagra inferior soltando los 3 tornillos de sujeción (A). Suelte el eje (B) de la posición derecha y móntelo en la posición izquierda de la bisagra. Introduzca la bisagra inferior en el lateral izquierdo soltando previamente los 2 tornillos (C).

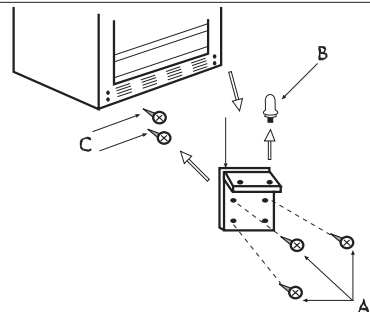

# CAMBIO DE SENTIDO DE APERTURA DE PUERTAS

- 6 Vuelva a colocar el zócalo inferior en su posición. Coloque la puerta inferior introduciéndola en el eje de la bisagra inferior.

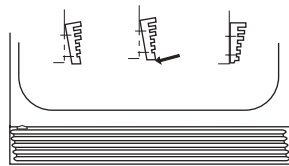

- 7 Quite el tapón del eje izquierdo de la puerta inferior y póngalo en el eje derecho (los modelos panelables no llevan este tapón).

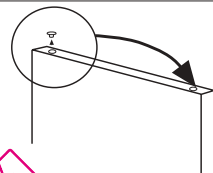

- 8 Introduzca la bisagra intermedia en el eje izquierdo de la puerta inferior y atorníllela al frigorífico. Coloque la puerta superior introduciéndola en el eje de la bisagra intermedia. A continuación coloque la plaquita protectora que oculta los tornillos de sujeción.

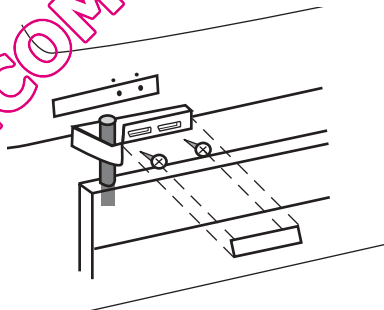

- 9 Introduzca la bisagra en su alojamiento de la parte izquierda del panel de mandos y en el eje de la puerta superior simultáneamente. Sujete la bisagra con el tornillo lateral.

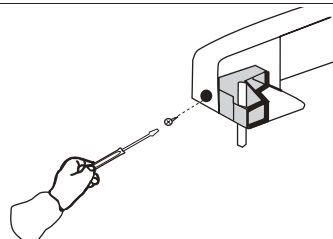

- 10 Introduzca la carcasa del panel de mandos presionando sobre el soporte hasta enganchar las pestañas de sujeción.

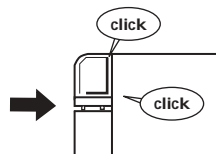

- 11 Si su frigorífico es panelable deberá cambiar de lado los tiradores de las puertas.

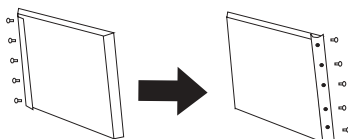

# PANELACION

Si su frigorífico es un modelo panelable y desea asemejar el aspecto exterior de su frigorífico al resto del mobiliario de su cocina, puede revestir las puertas con paneles siguiendo estas instrucciones.

- 1** Dimensiones del mueble frigorífico y de los paneles de puertas.  
(Espesor de paneles menor de 4 mm).

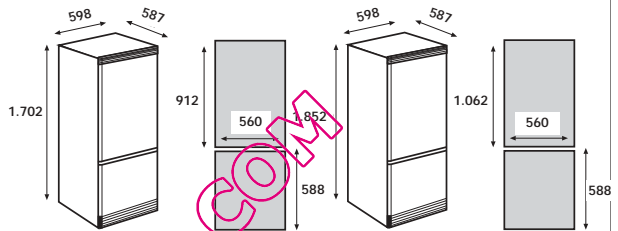

- 2** Extraiga el tirador y/o el marco del lado izquierdo de la puerta soltando los correspondientes tornillos.

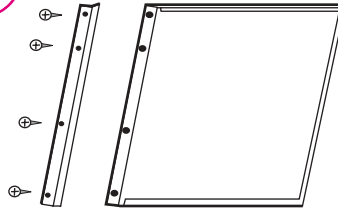

- 3** Afloje el resto de tornillos del contorno de la puerta sacando los marcos como indica la figura, e introduzca el panel deslizándolo.

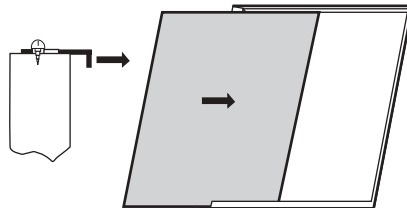

- 4** Apriete el reborde del marco contra el panel y sujete los tornillos del marco en esa posición. Coloque el tirador con sus tornillos.

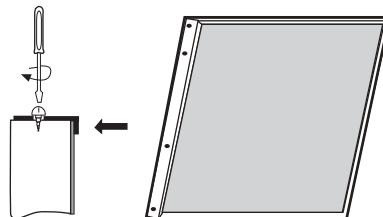



# PROBLEMAS DE FUNCIONAMIENTO

PROBLEMA	CAUSA POSIBLE	SOLUCION
El frigorífico no funciona	El enchufe no está conectado a la toma de corriente.	Conectar enchufe.
	No llega corriente eléctrica al enchufe por haberse fundido el fusible o por haber saltado el limitador automático de potencia.	Cambiar fusible o volver a conectar el limitador automático de potencia.
El refrigerador enfría poco	El mando termostato se encuentra en una posición baja.	Gire el mando termostato a una posición de más frío.
	Se ha dejado la puerta mal cerrada o se ha abierto con mucha frecuencia.	Cuidar que la puerta no permanezca abierta mucho tiempo.
	Se ha obstaculizado la rejilla de aireación o la abertura de la parte posterior del techo.	Conservar libres estas zonas según se indica en el capítulo "Instalación" de este manual.
Gotas de agua en la pared del fondo del refrigerador	El frigorífico está expuesto directamente a los rayos de sol o a una fuente de calor.	Cambiar la ubicación del frigorífico o protegerlo de esas fuentes de calor.
	Ciclo automático de deshielo.	No se alarme: esto es completamente normal (ver capítulo "Utilización del refrigerador" de este manual).
Aparece agua en la base del refrigerador	Se ha colocado algún alimento o recipiente pegado a la pared del fondo del refrigerador.	No ponga alimentos o recipientes en contacto con la pared del fondo y evitará el derrame del agua de deshielo.
	El desagüe del refrigerador está obstruido.	Desatasque el desagüe, según se indica en el capítulo "Utilización del refrigerador" de este manual.
Mucho hielo en las paredes y estantes del congelador	La puerta congelador no cierra bien por estar obstaculizada.	Procure un buen cierre de las puertas manteniéndolas libres de objetos o suciedad.
La lámpara del refrigerador no enciende	El enchufe no está conectado a la toma de corriente.	Conectar enchufe.
	No llega corriente eléctrica al enchufe por haberse fundido el fusible o por haber saltado el limitador automático de potencia.	Cambiar fusible o volver a conectar el limitador automático de potencia.
	La lámpara está floja.	Enroscar correctamente.
Funcionamiento ruidoso	La lámpara está fundida.	Cambiar la lámpara según se indica en este manual.
	El frigorífico no ha sido nivelado correctamente.	Nivelar según se indica en el capítulo "Instalación" de este manual.
Ruido de borboteo	Ciclo funcionamiento.	No se alarme, esto es completamente normal.
Los alimentos se secan	Los alimentos no están envueltos o tapados.	Envolverlos o introducirlos en recipientes herméticos.
Olores en el interior	Algún alimento no está correctamente envuelto o tapado.	Envolverlo o introducirlo en un recipiente hermético.
	El interior del aparato necesita una limpieza.	Limpia según se indica en este manual.

## SERVICIO DE ASISTENCIA TECNICA

Si Vd. ya ha realizado las comprobaciones indicadas y su problema persiste, NO EFECTUE NINGUNA OTRA REPARACION VD. MISMO. Pongase en contacto con el Servicio de Asistencia Técnica más próximo.

## ESPECIFICACIONES

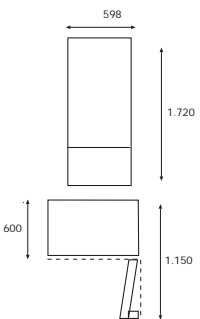
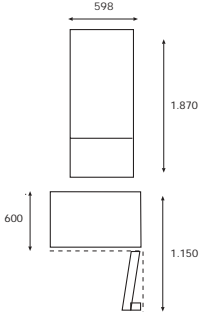
<p>. Dimensiones (en mm.)</p>		
-------------------------------	---	---

CE

ESTOS APARATOS CUMPLEN CON LAS  
DIRECTIVAS CEE: 73/23, 93/68, 89/336, 96/57

QUELFRIGO.COM

# INDICE

	Pag.
Instalação .....	2
Descrição geral.....	3
Posta em funcionamento.....	4
Utilização do refrigerador .....	5
Utilização do congelador.....	7
Limpeza e manutenção .....	11
Mudança de sentido de abertura das portas.....	12
Revestimento de painéis (só os modelos P/PB) ....	14
Problemas de funcionamento .....	15
Especificações.....	16

## ADVERTÊNCIA

Se o vosso antigo frigorífico dispõe de fecho de fechamento automático ou manual, **NÃO ESQUEÇA DE DESTRUIR OU INUTILIZAR O SISTEMA DE FECHAMENTO** antes de jogá-lo no ferro-velho. Com isto evitará que os miúdos ao brincarem possam ficar trancados dentro. **NÃO ESTRAGUE AS TUBAGENS** e evitará o escapamento incontrolado de refrigerante na atmosfera.

## SEGURANÇA

- O modelo de frigorífico que você adquiriu comercializa-se com os refrigerantes R600a ou R134a. Pode verificá-lo olhando na placa de características, e se o seu frigorífico utiliza R600a tenha em conta que:
  - Este refrigerante não deteriora o meio ambiente.
  - É inflamável, pelo que certifique-se de que o circuito frigorífico está em perfeitas condições. Se tem sofrido algum dano, procure o seu distribuidor antes de ligar.
- Este aparelho unicamente pode ser concertado pelo serviço de assistência técnica e utilizando peças de reposições originais.
- Não utilize elementos com fogo e nem aparelhagem eléctrica dentro do aparelho.
- Não deixe que as crianças brinquem com o aparelho.
- Evite que o fio esteja em contacto com o compressor.
- Evite que o fio fique preso debaixo do aparelho.
- Para evitar danos ao meio ambiente e recuperar materiais, utilize o serviço de recolha municipal.



# INSTALAÇÃO

## RECOMENDAÇÕES

Permitir a circulação do ar pela parte posterior do frigorífico. Não tampar a grade da frente nem o tecto do frigorífico com nenhum objecto. Se for instalado um armário encima, deve ter um óco para que circule o ar.

A classe climática do seu frigorífico acha-se indicada na placa de características. Esta determina o rango de temperatura ambiente para o qual está desenhada a unidade frigorífica e nas quais garante-se o correcto funcionamento do aparelho. Quando se indicam as duas classes, garante-se o correcto funcionamento nas condições de cada uma delas.

Classe	Temperaturas
N	16° até 32°
ST	18° até 38°
T	18° até 48°

Evitar dentro do possível a proximidade de fontes de calor.

Se necessitar deitar o frigorífico para ser desembalado ou mudar o sentido da giro das portas, **SOMENTE SE PODE DEITAR SOBRE A PARTE POSTERIOR.**

NOTA: As dobradiças das portas estão no lado direito. Se esta posição é incomoda para Vovê, é possível mudar de lado as dobradiças. No anexo MUDANÇA DE SENTIDO DE ABERTURA DAS PORTAS estão as instruções.

**IMPORTANTE:** Regulando os pés de nivelamento, comprovar que o frigorífico fique bem apoiado no chão (sem mancar) e bem nivelado (não de lado).

Este frigorífico funciona a 220/230v. Se Você dispõe duma tensão diferente na vossa casa, deve utilizar um transformador de potência não inferior a 500 W. Utilize uma tomada com TOMA DE TERRA.

NOTA: O fabricante declina de toda responsabilidade no caso de que não sejam seguidas estas recomendações.

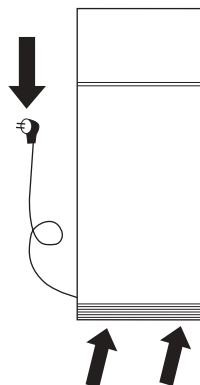
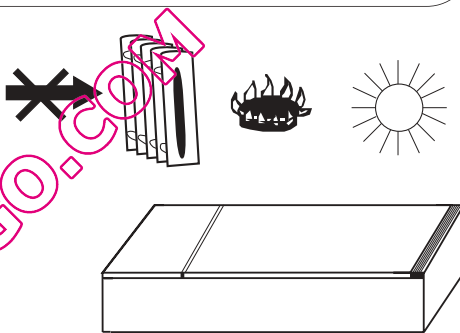

## ATENÇÃO ANTES DE LIGAR

1.- Limpar o interior do frigorífico.

2.- Para un correcto funcionamento, esperar 2 horas antes de ligar.

3.- Ligar.



# DESCRIÇÃO GERAL

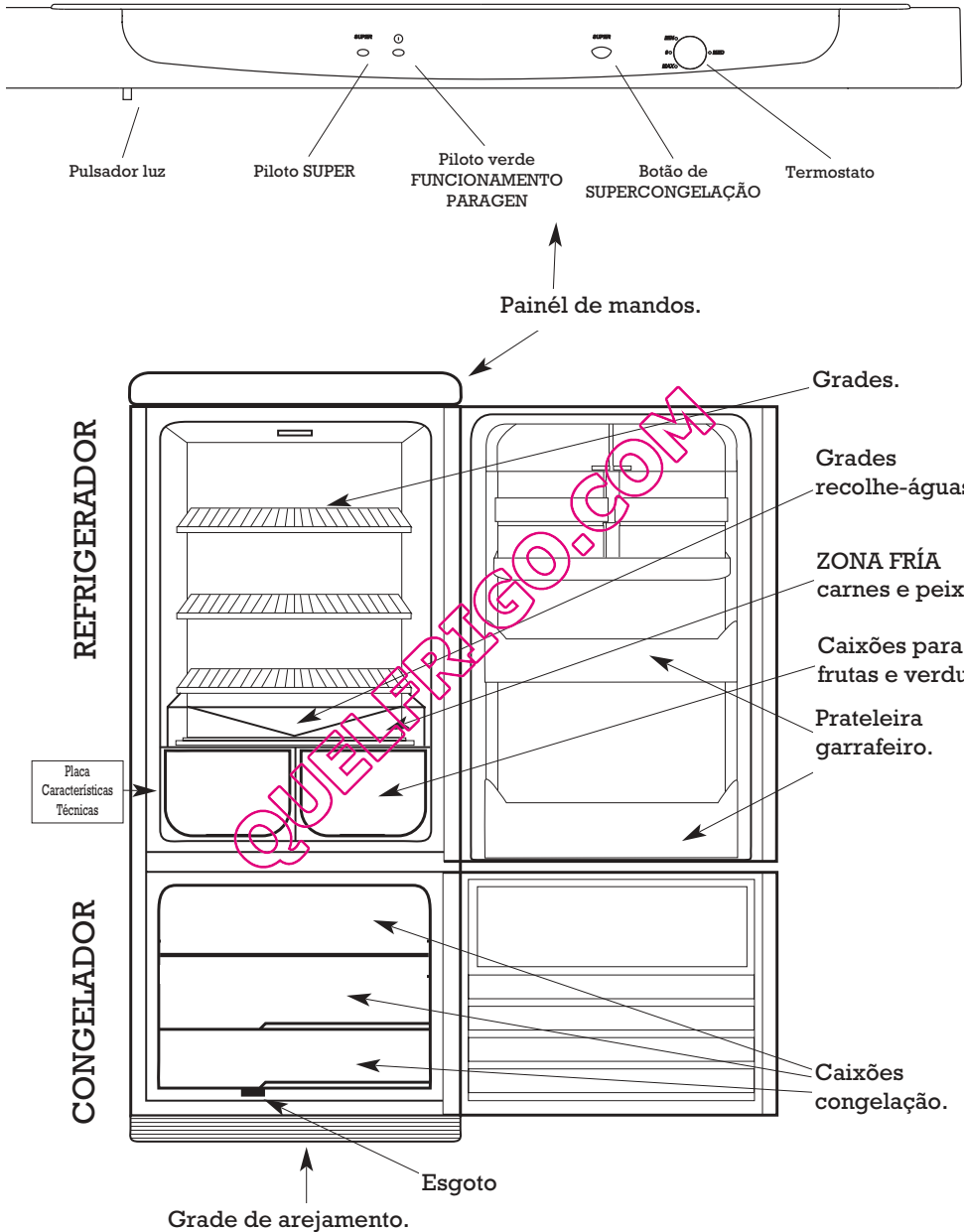

# POSTA EM FUNCIONAMENTO

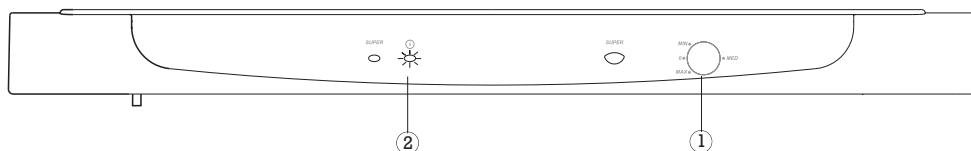

**1**

Girando o comando do termostato ① no sentido das agulhas de um relógio, o piloto ② acender-se-á e o frigorífico colocar-se-á em funcionamento.



**2**

Girando o comando termostato, seleccione mais frio (MAX) ou menos frio (MIN) no refrigerador. Inicialmente aconselha-se levar a uma posição intermédia.



# UTILIZAÇÃO DO REFRIGERADOR

## ALIMENTOS

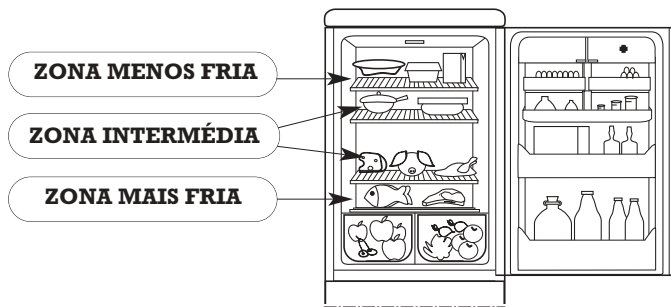

## ATENÇÃO

- Girando o mando termostáto pode-se seleccionar mais ou menos frio no refrigerador.
- Deverá ter em conta que a temperatura não é totalmente uniforme em todo o recinto, pelo que existem zonas adequadas para cada tipo de alimento (segundo figura).
- A temperatura no refrigerador pode ver-se afectada pela temperatura ambiente, a ubicação do aparelho e a frequência de abertura da porta.
- Não introduzir no refrigerador alimentos quentes ou líquidos sem tampar.
- Não introduzir NUNCA líquidos voláteis, inflamáveis ou explosivos, como dissolventes, álcoois, acetona ou gasolina. Existe risco de explosão.
- As carnes e peixes é conveniente embrulhá-los para evitar cheiros.

## SISTEMA MULTIFRESH

Se o seu frigorífico dispõe de um compartimento Multifresh:

- Este garante uma **conservação idónea** para alimentos frescos como carnes e peixes e também para hortaliças. Isso lhe permitirá conservar estes alimentos durante mais tempo sem necessidade de congelá-los.
- Neste recinto dispor-se-ão das **temperaturas mais frias** do refrigerador, sendo além disso a zona menos influenciada frente às frequentes aberturas.
- Para manter **carnes e peixes**, aconselha-se seleccionar uma temperatura intermedia no refrigerador.
- Para conseguir uma **maior capacidade** no refrigerador retire o tabuleiro superior deste recinto e a tampa. Pode utilizar desta forma o recinto. Com esta utilização o recinto perde as suas características iniciais.



# UTILIZAÇÃO DO REFRIGERADOR

## DESGELO

O sistema de degelo do refrigerador funciona automaticamente, por tanto não necessita nenhuma intervenção do usuário.

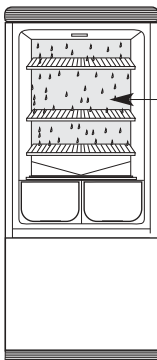

A parede do fundo do refrigerador estará habitualmente cheia de gotinhas de água ou gelo. Isto é totalmente NORMAL e forma parte do processo automático do degelo.

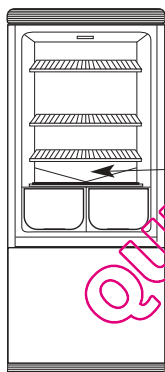

Se o canal recolhe-águas se enche devido à sujeira ou algum objecto que o obstrua, limpe-o. Evitará com isto que derrame água fora do canal recolhe-águas.

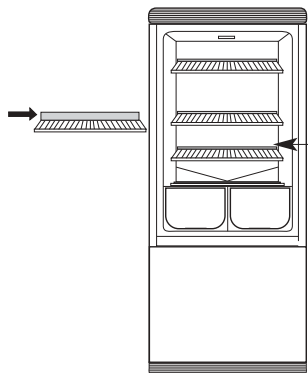

Procure que os alimentos não toquem a parede do fundo. Para isto as grades dispõem dum tope que não devem ser ultrapassado.



# UTILIZAÇÃO DO CONGELADOR

## CONGELAÇÃO DE ALIMENTOS FRESCOS

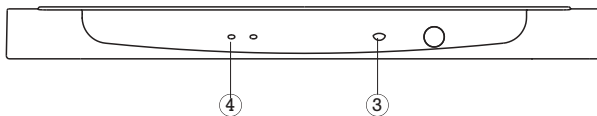

- 1** Introduzir os alimentos a congelar no congelador.

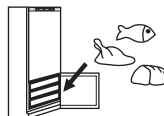

- 2** Pressione o botão de supercongelação ③ (SUPER). O piloto ④ acender-se-á.



- 3** 24 horas mais tarde, volte a pressionar o botão ③ desligando-o. O piloto ④ apagar-se-á. Os vossos alimentos estarão perfeitamente congelados.



## NOTA

- O congelador deste frigorífico tem categoria de **★ ★★★** 4 estrelas, em qualquer das suas gavetas, e é capaz de congelar em 24 horas os Kgs. indicados na placa de características.
- "Se você deseja congelar de uma só vez uma quantidade considerável de alimentos, obterá uma melhor congelação pressionando o botão de congelação rápida 24 horas antes, conseguindo desta maneira o mantimento das temperaturas adequadas no refrigerador, evitando que se esfrie em excesso."

## CONSELHOS

- Embrulhe os produtos a congelar em papel alumínio ou recipientes herméticos.
- Prepare os alimentos em porções consumíveis de uma só vez.
- Nunca congele por segunda vez um alimento descongelado.
- Coloque uma etiqueta na envoltura indicando o conteúdo e a data de congelação.
- Não ponha em contacto directo os alimentos a congelar com os já congelados.
- Não armazene no congelador bebidas gasosas.
- Os gelados não devem ser consumidos demasiado frios.

# UTILIZAÇÃO DO CONGELADOR

## CONSERVAÇÃO DE ALIMENTOS CONGELADOS

### CONSELHOS

- Quando adquira alimentos congelados no comércio, procure que transcorra o menor tempo possível até à sua introdução no congelador.
- Preste atenção ao tempo de conservação marcado nas embalagens dos produtos congelados, tendo em conta que este congelador é de categoria **✱ \*\*\* ✱**.
- Para os alimentos congelados por si, consulte a tabela de tempos de conservação.

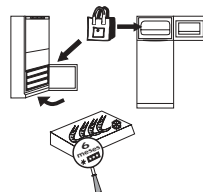

### TEMPO DE CONSERVAÇÃO

TIPO DE ALIMENTO	Número Meses
<b>PEIXE E MARISCO</b>	
Lagosta/crustáceos	3
Gambas-Lagostins	3
Pescada	2
Peixe gordo	3/4
Truta	2/3
Salmão	2/3
Linguado	3
Rodvalho	2/3
<b>CARNE</b>	
Vacuna	10/12
Borrego	6/8
Vitela	9
Porco	6
Febras/costoletas	4
Figado/rim	10
Língua	2
Carne picada, salsichas	2
Coelho	5/7
<b>AVES E CAÇA</b>	
Galinha/fango	10
Perú (aos pedaços)	7
Pato/ ganso	5
Lebre	6
Perdiz-Codorniz	8
Faisão	7/8
Caça grossa	10
<b>PRATOS PREPARADOS</b>	
Molho de tomate	3
Caldo de Carne	3
Asados: vitela, frango, porco	2/3
Sopas de legumes	3
Carne cozida, Estofada	3
Hamburguers	2
Pimentos recheados	2
Espinafres	2
Feijão verde	2
Tartes	5/6
Macedonias de fruta	3
Sandes	6

TIPO DE ALIMENTO	Número Meses
<b>LEGUMES</b>	
Selgas	12
Alcachofas	12
Cenouras	12
Couveiros	6/8
Couves de Bruxelas	6
Espargos	12
Couve	6/8
Feijão	12
Cogumelos	6
Salsa	12
Pimentos	12
Espinafres	12
Fabas	12
<b>FRUTA</b>	
Alperches	8
Cerejas, ameixas, framboesas, groselhas, e amoras	10
Poseegos	10/12
Morangos	12
Compotas (maça, pera)	10
Uva	10/12
Sumos fruta	10
Ananás	10/12
<b>PÃO E PASTELARIA</b>	
Biscoitos-Tartes	6
Massa folhada	1
Masa pasteleira	3
Pão e bolos	2
<b>OVOS, LEITE E DERIVADOS</b>	
Ovos (sem casca)	6
Leite homogeneizada (embalagem de cartão)	3
Manteiga	6
Queijo (pequenas doses)	6/8
Natas fresca	3

# UTILIZAÇÃO DO CONGELADOR

## DESCONGELAÇÃO DOS ALIMENTOS

Nem todos os alimentos devem ser descongelados da mesma maneira.

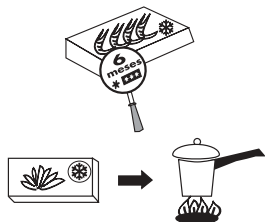

Se Você adquiriu o alimento congelado no comércio, siga as instruções do vasilhame.

As verduras devem cozinhar-se directamente.

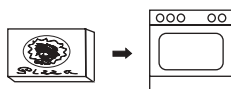

Geralmente, os alimentos preparados ou pré-cozinhados podem cozinhar-se directamente.

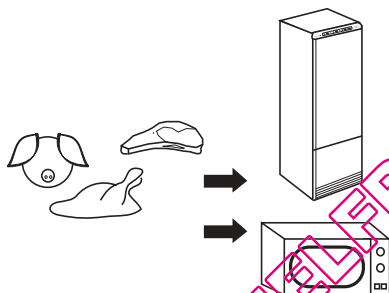

Carnes e peixes ter-se-ão de descongelar lentamente no refrigerador durante várias horas. Se Você dispõe de forno microondas, poderá acelerar a descongelação mais rapidamente.

## PRODUÇÃO DOS CUBINHOS DE GELO

- 1** Encha até as três quartas partes de água as formas que encontrará no interior do congelador.



- 2** Introduza as formas no congelador, preferivelmente na parte superior.

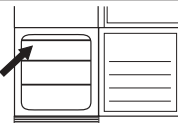

- 3** Uma vez congelada a água, pode desenformar os cubinhos retorcendo levemente as formas.

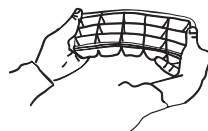

# UTILIZAÇÃO DO CONGELADOR

## DESGELO E LIMPEZA

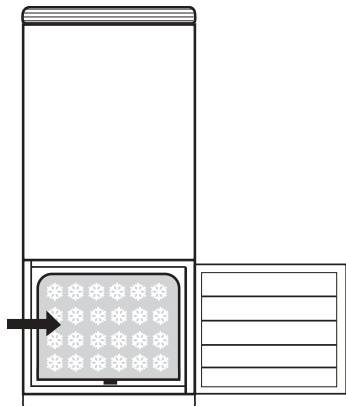

Com o tempo, nas paredes do congelador se vai formando uma capa de escarcha ou gelo. Isto provocará um maior consumo de energia no vosso frigorífico. Para evitá-lo, terá que eliminar esta capa de gelo, ao menos 2 vezes ao ano.

- 1** Girando o comando do termóstato no sentido contrario das agulhas de um relógio, apagar-se-á o piloto e o frigorífico ficará desligado.



- 2** Retire os alimentos congelados, embrulhe-os em papel de jornal e introduza-os no refrigerador, já que uma subida excessiva da temperatura dos alimentos poderia diminuir a duração destes.

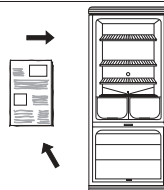

- 3** Deixe a porta aberta e puxe a calha elástica que se encontra na base do congelador. Coloque por baixo desta, qualquer um dos cestos, excepto o inferior, para proceder à recolha da água. Uma vez finalizada a tarefa, recolha a calha para a sua posição inicial.

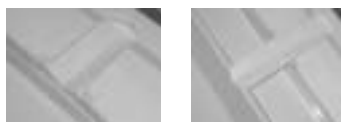

- 4** Pode ajudar a eliminar o gelo através da uma pázinha ou introduzindo um recipiente com água quente. Não utilize objectos afiados nem aparelhos de aquecimentos eléctricos.

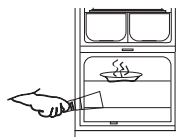

- 5** Seque bem o interior.

- 6** Gire o comando do termóstato no sentido das agulhas de um relógio, acender-se-á o piloto e o frigorífico ficará ligado.

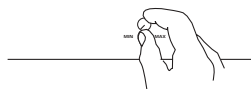

- 7** 2 horas mais tarde pode voltar a introduzir os alimentos congelados no congelador.



# LIMPEZA E MANUTENÇÃO

## LIMPEZA

### CONSELHOS

Para a limpeza do interior o frigorífico deve estar desligado.

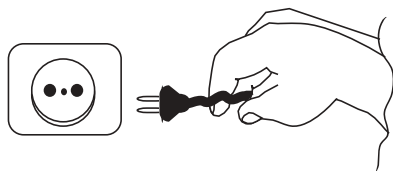

Não utilize produtos abrasivos, dissolventes, limpadores de metais ou detergentes não diluídos.



Evite derramar água sobre o tecto ou limpá-lo com panos molhados em excesso. Poderia estragar o frigorífico.

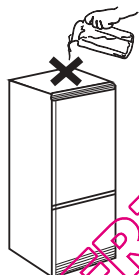

É conveniente limpar uma vez ao ano com un aspirador a grade da parte posterior do frigorífico. A sujeira prejudica o funcionamento e aumenta o consumo de energia eléctrica.

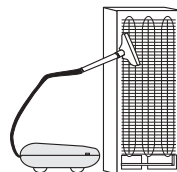

### PARADA TEMPORAL DO FRIGORIFICO

- Desligue o frigorífico.
- Retire os alimentos, limpe e seque o interior.
- Deixe a porta aberta para evitar a formação de mau cheiro.
- Faça o mesmo no caso de corte de corrente eléctrica prolongado ou falha do frigorífico.

### TROCA DA LÂMPADA

1- Desligar o frigorífico.

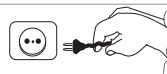

2- Retirar a lâmpada estragada e repô-la com outra do mesmo tipo.

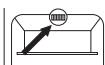

220 v  
15 w max.

## MUDANÇA DE SENTIDO DE ABERTURA DAS PORTAS

- 1 Retirar a carcaça do painel de mandos introduzindo a ponta duma chave-de-fenda na ranhura de amarração, fazendo saprema até libertar as pestanhas.

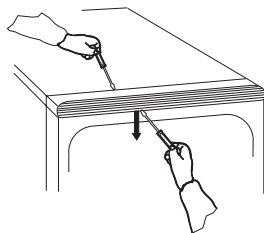

- 2 Extrair a dobradiça superior soltando previamente o parafuso de sujeição. Segure a porta superior com as duas mãos e retire-a do frigorífico.

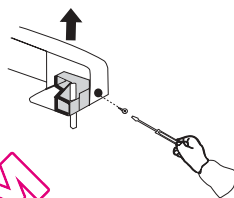

- 3 Extrair a dobradiça intermédia retirando a chapinha protectora que oculta os parafusos e soltando-os segure a porta inferior com as duas mãos e retire-a do frigorífico.

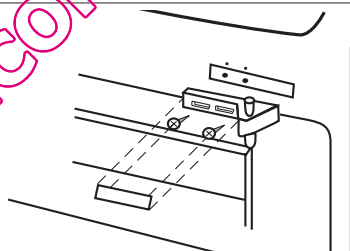

- 4 Extrair o rodapé inferior tal e como se indica na figura. Em seguida, rasgue a parte esquerda marcada no rodapé para alojar a dobradiça inferior segundo a figura.

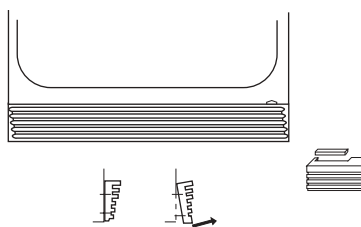

- 5 Extrair a dobradiça inferior soltando os 3 parafusos de sujeição (A). Solte o eixo (B) da posição direita e monte-o na posição esquerda da dobradiça. Introduza a dobradiça inferior no lateral esquerdo soltando previamente os 2 parafusos (C).

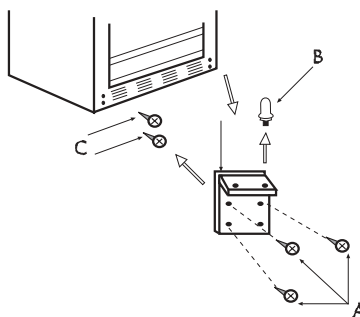

## MUDANÇA DE SENTIDO DE ABERTURA DAS PORTAS

Volte a colocar o rodapé inferior na sua posição.

- 6 Coloque a porta inferior introduzindo-a no eixo da dobradiça inferior.

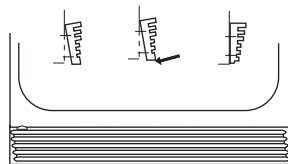

Retire o tampão do eixo esquerdo da porta inferior e ponhá-o no eixo direito (os modelos paneláveis não levam este tampão).

7

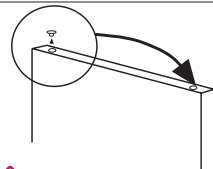

Introduza a dobradiça intermédia no eixo esquerdo da porta inferior e parafuse-a ao frigorífico, retirando previamente o protector dos furos. Coloque a parte superior introduzindo-a no eixo da dobradiça intermédia. Continuação colocar o por a placa que protege os tornilhos de apertar.

8

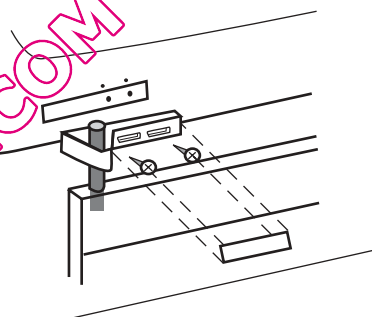

Introduza a dobradiça no seu alojamento da parte esquerda do painel de mandos e no eixo da porta superior simultaneamente. Sujeite a dobradiça com o parafuso lateral.

9

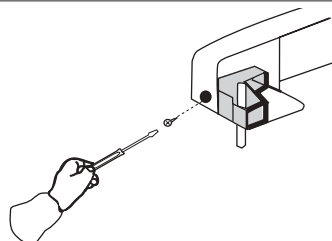

Introduza a carcaça do painel de mandos pressionando sobre o suporte até engatar as pestanhas de sujeição.

10

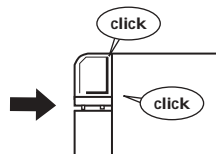

Se o vosso frigorífico é revestível deverá mudar de lado os puchadores das portas.

11

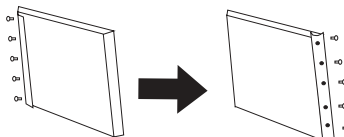

## REVESTIMENTO DE PAINÉIS

Se o vosso frigorífico é um modelo revestível e deseja assemelhar o aspecto exterior do vosso frigorífico com o resto do mobiliário da vossa cozinha, pode revestir as portas com painéis seguindo estas instruções.

1

**Dimensões do móvel frigorífico e dos painéis das portas.**  
(Espesor dos painéis menor de 4 mm)

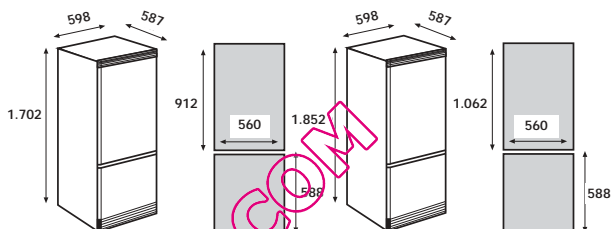

2

Extrair o puchador e/ou o marco do lado esquerdo da porta soltando os correspondentes parafusos.

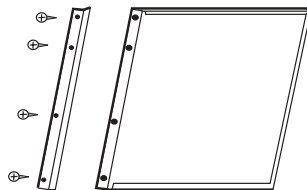

3

Afrouxe o resto dos parafusos do contorno da porta retirando os marcos como indica a figura, e introduza o painel, deslizando-o.

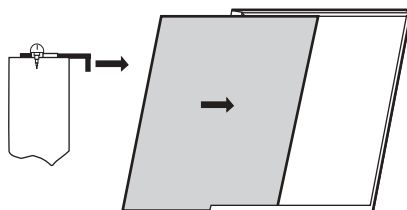

4

Aperte a beirada do marco contra o painel e sujeite os parafusos do marco nessa posição. Coloque o marco e/ou o puchador com os seus parafusos.

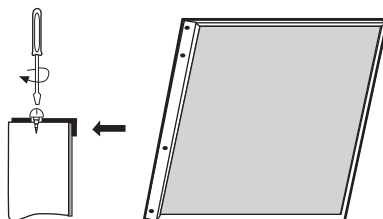



# PROBLEMAS DE FUNCIONAMENTO

PROBLEMA	CAUSA POSSIVEL	SOLUÇÃO
O frigorífico não funciona.	O pino não está ligado à tomada de corrente.	Ligar tomada.
	Não chega corrente eléctrica a tomada por ter-se fundido o fusível ou por ter pulado o limitador automático de potência.	Trocar os fusíveis ou voltar a ligar o limitador automático de potência.
O refrigerador esfria pouco.	O mando termostáto acha-se numa posição baixa.	Gire o mando termostáto a uma posição de mais frio.
	Tem-se deixado a porta mal fechada ou tem-se aberto com muita frequência.	Cuidar que a porta não permaneça aberta muito tempo.
	Obstaculizou-se a grade de arejamento ou a abertura da parte traseira do tecto.	Conservar livres estas zonas segundo indica-se no capítulo "Instalação" deste manual.
Gotas de água na parede do fundo do refrigerador.	O frigorífico está exposto directamente aos raios do sol ou a uma fonte de calor.	Mudar o frigorífico de lugar ou protegê-lo dessas fontes de calor.
	Ciclo automático de degelo.	Não se preocupe: isto é completamente normal (Ver capítulo "Utilização do refrigerador" deste manual).
Aparece água debaixo do refrigerador.	Se tiver colocado algum alimento ou recipiente encostado à parede do fundo do refrigerador.	Não coloque alimentos ou recipientes em contacto com a parede do fundo e evitará o derramamento de água do degelo.
	O esgoto do refrigerador está entupido.	Desentupir o esgoto, segundo se indica no capítulo "Utilização do refrigerador" deste manual.
Muito gelo nas paredes e prateleiras do congelador.	A porta do congelador não fecha bem por estar obstaculizada.	Procure que estejam bem fechadas as portas mantendo-as livres de objectos ou sujeira.
A lâmpada do refrigerador não acende.	O pino não está ligado à toma de corrente.	Ligar a tomada.
	Não chega corrente eléctrica à tomada por ter-se fundido o fusível ou por ter pulado o limitador automático de potência.	Trocar o fusível ou voltar a ligar o limitador automático de potência.
	A lâmpada está queimada.	Rosquear correctamente.
	A lâmpada do refrigerador está frouxa.	Trocar a lâmpada segundo indica-se no capítulo "Instalação" deste manual.
Funcionamento barulhento.	O frigorífico não foi nivelado correctamente.	Nivelar segundo indicase no capítulo "Instalação" deste manual.
Barulho de borbulhas.	Ciclo funcionamento.	Não se preocupe, isto é completamente normal.
Os alimentos secam-se.	Os alimentos não estão embrulhados ou tampados.	Embrulhá-los ou introduzir em recipientes herméticos.
Cheiro no interior.	Algum alimento não está correctamente embrulhado.	Embrulhar ou introduzir em recipientes herméticos.
	O interior do aparelho necessita uma limpeza.	Limpar segundo indicase neste manual.

## SERVIÇO DE ASSISTÊNCIA TÉCNICA

Se Você já realizou as comprovações indicadas e o vosso problema persiste, NÃO FAÇA NENHUMA OUTRA REPARAÇÃO VOCÊ MESMO. Ponha-se em comunicação com o Serviço de Assistência Técnica mais próximo.

## ESPECIFICAÇÕES

• Dimensões em mm.

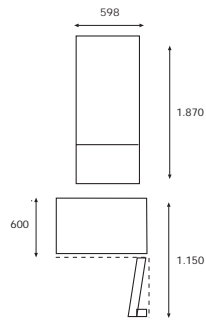
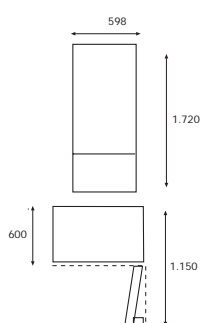

ESTES APARELHOS CUMPREM AS  
DIRECTIVAS DA CEE: 73/23, 93/68, 89/336, 96/57

QUELFRIG.COM

# INDEX

	Page
Installation .....	2
Description générale .....	3
Mise en fonctionnement .....	4
Utilisation du réfrigérateur .....	5
Utilisation du congélateur .....	7
Nettoyage et entretien .....	11
Changement du sens d'ouverture des portes .....	12
Lambrissage a panneaux (uniquement sur les modèles P et PB) .....	14
Problèmes de fonctionnement.....	15
Spécifications .....	16

## AVIS

Si votre ancien réfrigérateur dispose de pénes à fermeture automatique ou manuelle, **N'OUBLIEZ PAS DE DETRUIRE OU D'INUTILISER LE SYSTEME DE FERMETURE** avant de l'envoyer à la ferraille. Ceci évitera que, dans leurs jeux, des enfants puissent demeurer enfermés à l'intérieur.

**N'ENDOMMAGEZ PAS LES TUYAUTERIES** et vous éviterez ainsi que le réfrigérant puisse s'échapper sans contrôle dans l'atmosphère.

## SECURITÉ

- Le modèle de réfrigérateur que vous venez d'acquérir est commercialisé avec les réfrigérants R600a ou R134a. Vous pourrez vérifier quel est le réfrigérant utilisé en regardant sur la plaque signalétique. Si votre réfrigérateur emploie du R600, tenez compte des éléments suivants :
  - Ce réfrigérant ne détériore pas l'environnement.
  - Il est inflammable, assurez-vous donc que le circuit frigorifique se trouve dans de parfaites conditions. S'il est endommagé, consultez le distributeur avant de procéder à son branchement.
- Cet appareil peut uniquement être réparé par le service d'assistance technique qui utilisera pour cela des pièces détachées originales.
- N'utilisez pas d'éléments avec du feu ou d'appareils électriques à l'intérieur de l'appareil.
- Ne laissez pas les enfants jouer avec l'appareil.
- Evitez que le câble ne soit en contact avec le compresseur.
- Evitez que le câble ne soit pris sous l'appareil.
- Pour ne pas nuire à l'environnement et récupérer les matériaux utilisés, faites appel au service de voirie municipale.



# INSTALLATION

## RECOMMANDATIONS

Permettre la circulation de l'air sur la partie postérieure du réfrigérateur. Ne permettre à aucun objet de boucher la grillage avant ou le faite du réfrigérateur. Si l'on installe une armoire au-dessus, il faudra laisser un creux pour permettre la circulation de l'air.

La classe climatique de votre réfrigérateur est indiquée sur la plaque signalétique. Celle-ci détermine le rang des températures ambiantes pour lequel l'unité frigorifique est conçue en garantissant le bon fonctionnement de l'appareil. Lorsque deux classes sont indiquées, le bon fonctionnement de l'appareil est assuré dans les conditions de chacune d'elles.

Classe	Températures ambiantes
N	16° à 32°
ST	18° à 38°
T	18° à 43°

Eviter dans toute la mesure du possible la proximité des sources de chaleur.

Si vous avez besoin de coucher le réfrigérateur pour le débiller ou pour changer de côté ses gonds de pivotement de ses portes, **LE REFRIGERATEUR NE PEUT ETRE COUCHE QUE SUR SA PARTIE POSTERIEURE.**

NOTE: Les charnières des portes se trouvent sur le côté droit. Si cette disposition s'avère gênante pour vous, il est possible de changer la place des charnières. Les instructions se trouvent dans l'annexe CHANGEMENT DU SENS D'OUVERTURE DES PORTIERES.

**IMPORTANT:** En réglant les pieds de nivellement, s'assurer que le réfrigérateur est bien appuyé sur le sol (sans boitement) et est bien nivelé (pas incliné).

Ce réfrigérateur fonctionne à 220/230v. Si vous disposez d'une tension différente dans votre foyer, vous devrez utiliser un transformateur d'une puissance non inférieure à 500 w. Utilisez une prise de courant avec MISE A TERRE.

NOTE: Le fabricant décline toute responsabilité au cas où ses instructions ne seraient pas suivies.

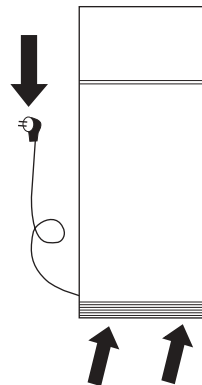
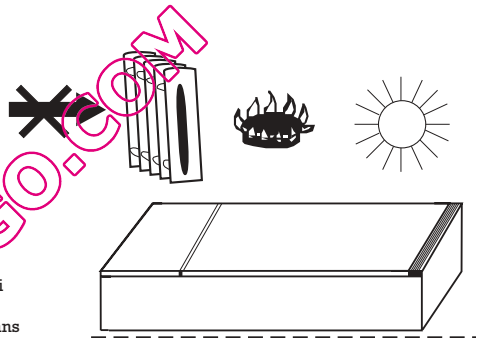

## ATTENTION AVANT DE CONNECTER

1.- Nettoyer l'intérieur du réfrigérateur.



2.- Pour un fonctionnement correct, attendre deux heures avant de le brancher.



3.- Connecter.



# DESCRIPTION GENERALE

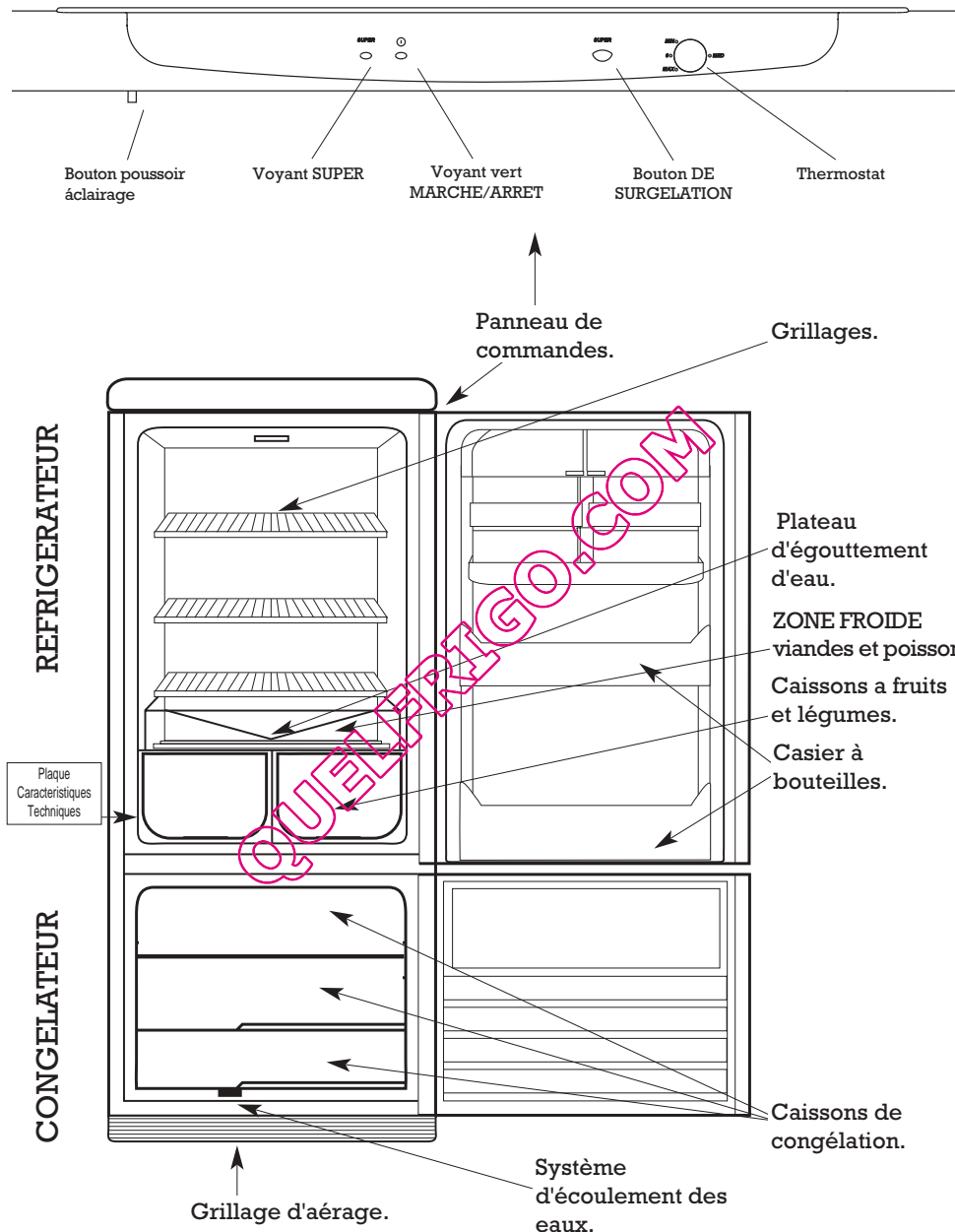

# MISE EN FONCTIONNEMENT

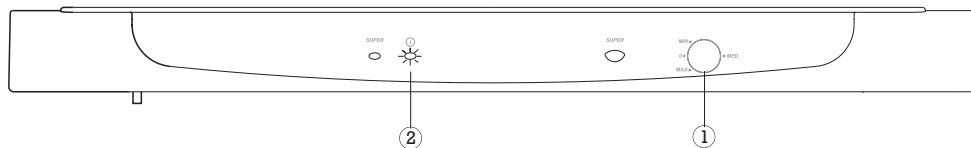

**1**

En tournant le bouton du thermostat <sup>①</sup> dans le sens des aiguilles d'une montre, le voyant <sup>②</sup> s'allumera et le réfrigérateur se mettra en route.



**2**

En tournant le bouton du thermostat, sélectionnez la température du réfrigérateur allant du plus froid (MAX) ou moins froid (MIN). Il est initialement recommandé de le régler à une température intermédiaire.



# UTILISATION DU REFRIGERATEUR

## ALIMENTS

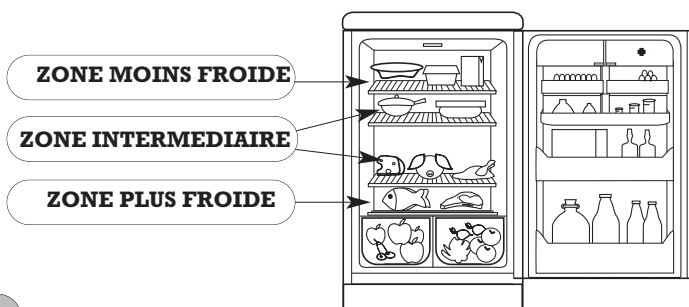

## ATTENTION

- En tournant la commande du thermostat, on peut sélectionner plus ou moins de froid dans le réfrigérateur.
- Il y a lieu de prendre en considération que la température n'est pas totalement uniforme dans toute l'enceinte, raison pour laquelle il y a des zones appropriées pour chaque type d'aliment (suivant la figure).
- La température dans le réfrigérateur peut être affectée par la température ambiante, l'emplacement de l'appareil et la fréquence d'ouverture de la porte.
- Ne pas introduire dans le réfrigérateur des aliments chauds ou des liquides non bouchés.
- Ne JAMAIS introduire des liquides volatiles, inflammables ou explosifs, tels que des dissolvants, des alcools, de l'acétone ou de l'essence. Il y aurait un risque d'explosion.
- Il convient d'envelopper les viandes et les poissons pour éviter des odeurs.

## SYSTEME MULTIFRESH

Si votre réfrigérateur dispose d'un compartiment Multifresh:

- Il garantit une **conservation idéale** pour les aliments frais tels que la viande, le poisson et les légumes. Cela vous permettra de conserver ces aliments plus longtemps sans avoir besoin de les congeler.
- Cette enceinte disposera des **températures les plus froides** du réfrigérateur. Cette zone étant également la moins affectée par les ouvertures fréquentes.
- Pour conserver la **viande et le poisson**, il est recommandé de sélectionner une température intermédiaire dans le réfrigérateur.
- Pour **augmenter la capacité** du réfrigérateur, retirer le plateau supérieur de l'enceinte et le couvercle et entreposer directement sur le bac. Dans ce cas, l'enceinte perd les propriétés indiquées.



# UTILISATION DU REFRIGERATEUR

## DEGEL

Le système de dégel du réfrigérateur fonctionne de façon automatique et n'exige donc aucune intervention de l'utilisateur.

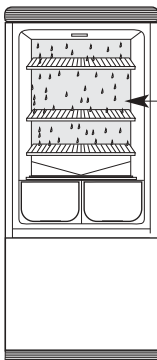

La paroi du fond du réfrigérateur sera habituellement couverte de gouttelettes d'eau ou de glace. Ceci est tout à fait NORMAL et fait partie du processus de dégel automatique.

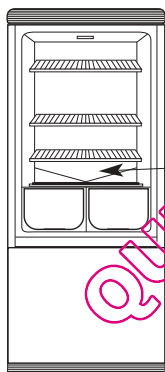

Si le canal récepteur d'eau se bouche par des impuretés ou est obstrué par un objet, le nettoyer . Ceci évitera que l'eau ne déborde du canal récepteur d'eau.

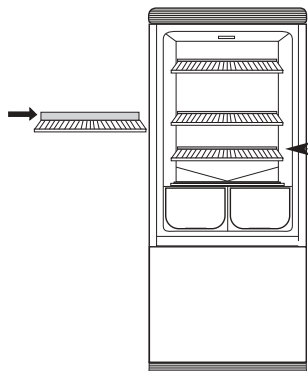

Veiller à ce que les aliments ne touchent pas la paroi du fond. A cette fin, les grillages sont pourvus d'une butée qu'il y a lieu de ne pas dépasser.



# UTILISATION DU CONGELATEUR

## CONGELATION D'ALIMENTS FRAIS

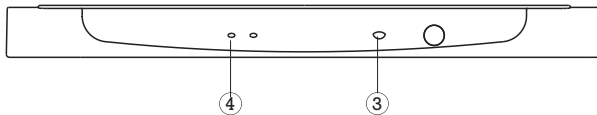

**1** Introduire les aliments à congeler dans le congélateur.

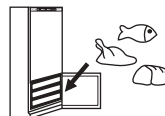

**2** Pousser sur le bouton de surgélation ③ (SUPER). Le voyant lumineux ④ s'allumera.



**3** 24 heures plus tard, pousser à nouveau sur le bouton ③ pour le déconnecter. Le voyant lumineux ④ s'éteindra. Vos aliments seront parfaitement congelés.

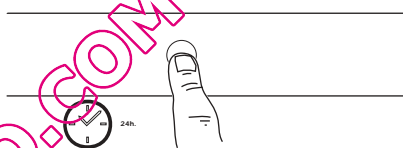

### NOTE

- Le congélateur de ce réfrigérateur a la catégorie d'un **★\*\*\*** 4 étoiles dans tous ses compartiments et est capable de congeler en 24 heures les kilos indiqués sur la plaque de caractéristiques.
- Si vous souhaitez surgeler en une seule fois une quantité considérable d'aliments, la congélation sera meilleure si vous appuyez sur le bouton de congélation rapide 24 heures avant, de sorte à maintenir les températures adéquates dans le réfrigérateur, tout en évitant qu'il ne se refroidisse trop.

### CONSEILS

- Envelopper les produits à congeler dans du papier aluminium ou les disposer dans des récipients hermétiques.
- Préparer les aliments en rations consommables en une seule fois.
- Ne jamais congeler une deuxième fois un aliment décongelé.
- Coller une étiquette sur l'emballage pour en indiquer le contenu et la date de congélation.
- Ne pas mettre en contact direct les aliments à congeler et ceux qui le sont déjà.
- Ne pas stocker dans le congélateur des boissons gazeuses.
- Les glaces ne doivent pas être consommées trop froides.

# UTILISATION DU CONGELATEUR

## CONSERVATION DES ALIMENTS CONGELES

### CONSEILS

- Lorsque vous achetez des aliments congelés ou surgelés dans le commerce, veillez à les laisser le minimum de temps possible en dehors du congélateur.
- Respectez la durée de conservation indiquée sur les emballages des produits congelés et surgelés, en tenant compte que votre congélateur est de \*\*\*.
- Pour les aliments que vous congelez vous-mêmes, consultez le tableau des temps de conservation ci-dessous.

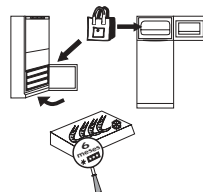

### TIEMPS DE CONSERVATION

TYPE D'ALIMENT	Nombre de mois
<b>POISSON ET FRUIT DE MER</b>	
Langouste-crustacés	3
Bouquets-cros bouquets	3
Colin	2
Poissons grass	3/4
Truite	2/3
Saumon	2/3
Soie	3
Turbot	2/3
<b>VIANDE</b>	
Gros bovin	10/12
Agneau	6/8
Porc	9
Filets et côtelettes	6
Foie/Rognons	4
Higado/Riñones	10
Cervelle/Langue	2
V viande hachée/saucisses	2
Lapin	5/7
<b>VALOILLES ET GIBIER</b>	
Poules-poulets	10
Dindon (découpé)	7
Canard, jars, oie	5
Lièvre	6
Perdrix-Caille	8
Faisan	7/8
Gros gibier	10
<b>PLATS CUISINES</b>	
Sauces de tomate	3
Consommé	3
Rôtis: boeuf, veau, poulet, porc	2/3
Jardinière de légumes	3
V viande cuite ou à l'étouffée	3
Bifteck haché (hamburger)	2
Poivrons farcis	2
Epinards	2
Haricots verts et sautés	2
Gâteau, friands, etc	5/6
Macédoine de fruits	3
Sandwichs	6

TYPE D'ALIMENT	Nombre de mois
<b>LEGUMES</b>	
Bettes	12
Artichauts	12
Carottes	12
Chou fleur	6/8
Chou de Bruxelles	6
Asperges	12
Choux	6/8
Haricots	12
Champignons	6
Persil	12
Poivrons	12
Epinards	12
Fèves	12
<b>FRUITS</b>	
Abricots	8
Cerises, prunes, framboises, groseilles, mûres	10
Pêches	10/12
Fraises	12
Compotes (pommes, poires)	10
Raisins	10/12
Jus de fruits	10
Ananas	10/12
<b>PAIN ET PASTELERIE</b>	
Biscuits, gâteaux	6
Gâteaux feuilleté	1
Pâte à pâtisserie	3
Pain et brioches	2
<b>OEUFs, LAIT ET DERIVES</b>	
Oeufs (san coque)	6
Lait homogénéisé (emballage carton)	3
Beurre	6
Fromages (petites portions)	6/8
Crème fraîche	3

# UTILISATION DU CONGELATEUR

## DECONGELATION D'ALIMENTS

Tous les aliments ne doivent pas être décongelés de la même façon.

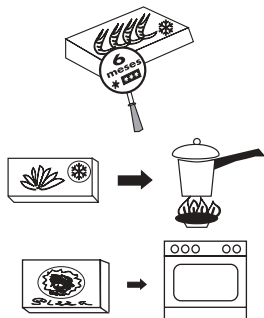

Si vous avez acheté l'aliment congelé dans le commerce, suivez les instructions indiquée sur l'emballage.

Les légumes doivent être cuisinés directement.

En général, les aliments préparés ou précuits peuvent être cuisinés directement.

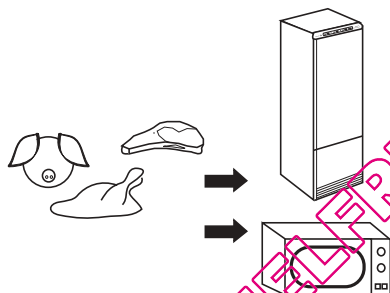

Les viandes et les poissons doivent être décongelés lentement dans le réfrigérateur pendant plusieurs heures. Si vous disposez d'un four à micro-ondes, vous pourrez accélérer la décongélation dans une grande mesure.

## PRODUCTION DES GLAÇONS

- 1** Remplir d'eau aux trois quarts les moules qui se trouvent à l'intérieur du congélateur.



- 2** Introduire les moules dans le congélateur, préférablement dans la partie supérieure.

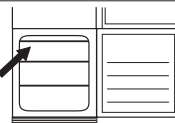

- 3** Une fois l'eau congelée, on peut extraire les glaçons de leur moule en tordant légèrement ce dernier.

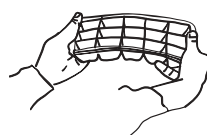

# UTILISATION DU CONGELATEUR

## DEGEL ET NETTOYAGE

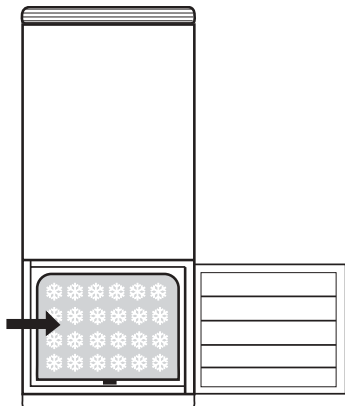

Avec le temps, il se forme sur les parois du congélateur une couche de givre ou de glace. Ceci entraînera une consommation plus grande d'énergie dans votre réfrigérateur. Afin de l'éviter, il y a lieu d'éliminer cette couche de glace au moins deux fois par an.

1

En tournant le bouton du thermostat dans le sens inverse des aiguilles d'une montre, le voyant s'éteindra et le réfrigérateur se déconnectera.



2

Retirer les aliments congelés, les envelopper dans du papier de journal et les introduire dans le réfrigérateur, vu qu'une élévation excessive de la température des aliments pourrait en réduire la durée.

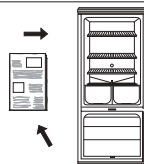

3

Laissez la porte ouverte et dépliez la languette élastique encastrée à la base du congélateur. Placez sous n'importe lequel des bacs, sauf le bac inférieur, pour ramasser l'eau. Une fois l'opération terminée, remettre la languette dans sa position initiale.

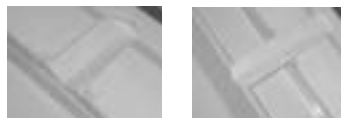

4

On peut aider à éliminer la glace à l'aide de une palette ou en introduisant un récipient d'eau chaude. Ne pas utiliser des objets tranchants ni des appareils de chauffe électriques.

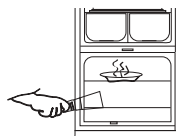

5

Sécher l'intérieur avec soin.

6

Tournez le bouton du thermostat dans le sens des aiguilles d'une montre, le voyant s'allumera et le réfrigérateur se connectera.

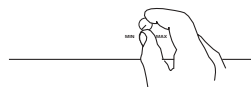

7

Deux heures plus tard, on peut introduire à nouveau les aliments congelés dans le congélateur.



# NETTOYAGE ET ENTRETIEN

## NETTOYAGE

### CONSEILS

Pour nettoyer l'intérieur, le réfrigérateur doit être débranché.

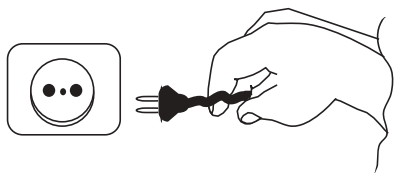

Ne pas utiliser de produits abrasifs, dissolvants, de nettoyage des métaux ou des détergents non dilués.

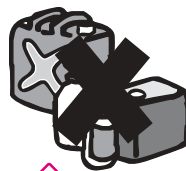

Éviter de répandre de l'eau sur le faite ou de le nettoyer avec des linges excessivement mouillés. Cela pourrait endommager le réfrigérateur.

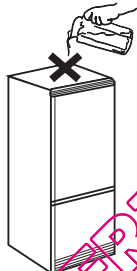

Il convient de nettoyer une fois par an avec un aspirateur le grillage arrière du réfrigérateur. La saleté a un effet préjudiciable sur le fonctionnement et augmente la consommation en énergie électrique.

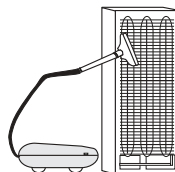

FRANCAIS

## ARRET PROVISOIRE DU REFRIGERATEUR

- Débrancher le réfrigérateur.
- Retirer les aliments, nettoyer et sécher l'intérieur.
- Laisser la porte ouverte afin d'éviter qu'il ne se forme de mauvaises odeurs.
- Agir de la même façon en cas de coupure prolongée de courant ou de panne du réfrigérateur.

## REMPACEMENT DES AMPOULES

1- Déconnecter le réfrigérateur.

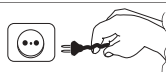

2- Enlever l'ampoule grillée et la remplacer par une autre du même type.



220 v  
15 w max.

E 14

# CHANGEMENT DU SENS D'OUVERTURE DES PORTES

- 1** Extraire la carcasse du panneau de commandes en introduisant la pointe d'un tournevis dans les rainures d'ancrage et louer jusqu'à la libération des pattes.

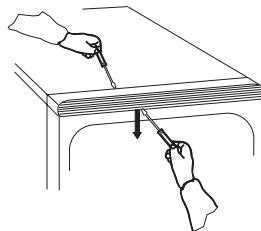

- 2** Déposer la charnière supérieure en enlevant d'abord la vis de fixation tout en immobilisant la porte supérieure avec les deux mains et puis retirer celle-ci du réfrigérateur.

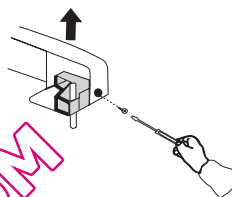

- 3** Déposer la charnière intermédiaire en retirant la plaque protectrice qui recouvre les vis et enlever celles-ci tout en immobilisant la porte inférieure avec les deux mains et puis retirer celle-ci du réfrigérateur.

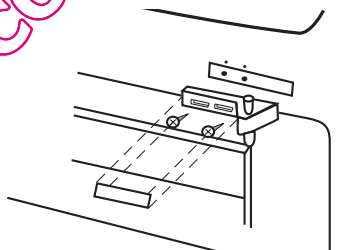

- 4** Déposer le socle inférieur comme il est indiqué sur la figure. Pour suivre, déchirer la partie gauche marquée du socle pour loger la charnière inférieure suivant la figure.

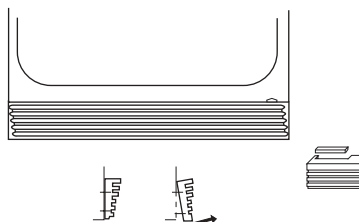

- 5** Déposer la charnière inférieure en enlevant les 3 vis de fixation (A). Déposer le gond (B) de la position droite et le monter dans la position gauche de la charnière. Introduire la charnière inférieure dans le côté gauche après avoir enlevé les deux vis (C).

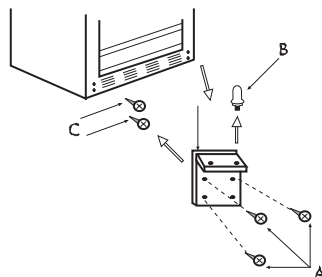

## CHANGEMENT DU SENS D'OUVERTURE DES PORTES

6

Replacer le socle inférieur en sa position. Placer la porte inférieure en y engageant le gond de la charnière inférieure.

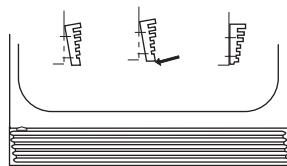

7

Enlever le bouchon du tube axial gauche de la porte inférieure et l'introduire dans le tube axial droit (les modèles habillables ne sont pas pourvus de ce bouchon).

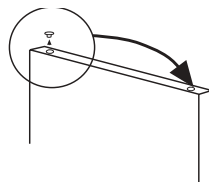

8

Introduire la gonde de charnière intermédiaire dans le tube axial gauche de la porte inférieure et visser la charnière au réfrigérateur après avoir enlevé le protecteur des orifices. Placer la partie supérieure en y engageant le gond de la charnière intermédiaire. Remonter ensuite la plaquette de protection cachant les vis de fixation.

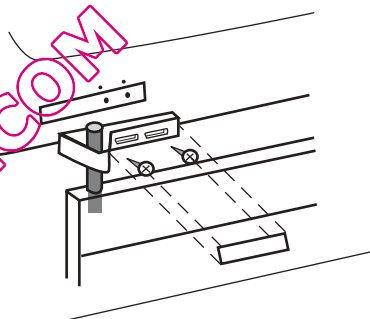

9

Introduire la charnière dans son logement de la partie gauche du panneau de commandes et, simultanément, dans le tube axial de la porte supérieure. Fixer la charnière avec la vis latérale.

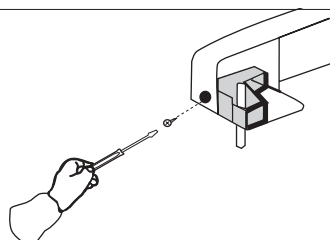

10

Introduire la carcasse du panneau de commandes en réalisant une pression sur le support jusqu'à l'accrochage des pattes de fixation.

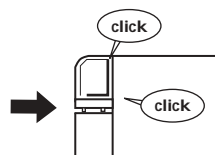

11

Si votre réfrigérateur admet le lambrissage à panneaux, il faudra changer de côté les poignées des portes.

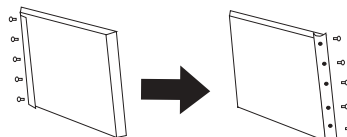

## LAMBRISSAGE A PANNEAUX

Si votre réfrigérateur est un modèle susceptible de lambrissage à panneaux et vous souhaitez que l'aspect extérieur de votre réfrigérateur soit semblable au reste du mobilier de votre cuisine, vous pouvez revêtir les portes au moyen de panneaux en suivant les instructions suivantes.

- 1** Dimensions du meuble du réfrigérateur et des panneaux de portes.  
(Épaisseur des parois inférieure à 4 mm)

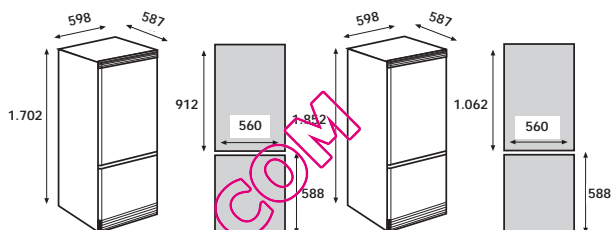

**2**

Déposer la poignée et/ou le cadre du côté gauche de la porte en enlevant les vis correspondantes.

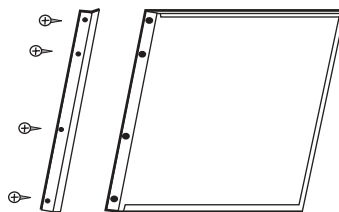

**3**

Desserrer le reste des vis du pourtour de la porte et enlever les cadres comme il est indiqué sur la figure et introduire le panneau en le glissant.

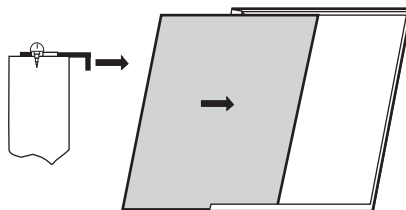

**4**

Serrer le rebord du cadre contre le panneau et serrer les vis du cadre dans cette position. Mettre en place le cadre et/ou la poignée avec leurs vis.

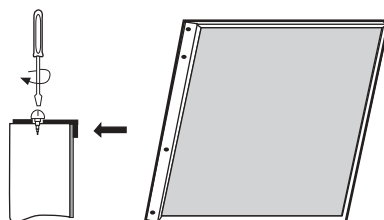



# PROBLEMES DE FONCTIONNEMENT

PROBLEME	CAUSE POSSIBLE	SOLUTION
Le réfrigérateur ne fonctionne pas.	La fiche n'est pas connectée à la prise de courant.	Connecter la fiche.
	Le courant électrique n'arrive pas à la fiche car le fusible est fondu ou le limiteur automatique de puissance a sauté.	Changer le fusible ou reconnecter le limiteur automatique de puissance.
Le réfrigérateur refroidit peu.	La commande de thermostat se trouve en une position basse.	Tourner la commande du thermostat sur une position plus froide.
	On a laissé la porte mal fermée ou on l'a ouverte avec une fréquence excessive.	Veiller à ce que la porte ne reste pas longtemps ouverte.
	On a abstrué le grillage d'aéragé ou l'ouverture de la partie arrière du faite du réfrigérateur.	Conservé ces zones libres comme il est indiqué au chapitre "Installation" de ce manuel.
Il y a des gouttes d'eau sur la paroi du fond du réfrigérateur.	Le réfrigérateur est directement exposé aux rayons du soleil ou à une source de chaleur.	Changer l'emplacement du réfrigérateur ou le protéger contre ces sources de chaleur.
	Cycle automatique de dégel.	Ne pas s'alarmer: c'est tout à fait normal (voir le chapitre "Utilisation du réfrigérateur" de ce manuel).
Il apparait de l'eau sur en bas du réfrigérateur.	On a placé un aliment ou un récipient contre la paroi du fond du réfrigérateur.	Ne pas placer d'aliments ou de récipients en contact avec la paroi du fond; ceci évitera l'écoulement de l'eau de dégel.
	Le système d'écoulement des eaux du réfrigérateur est bouché.	Déboucher le système d'écoulement, comme il est indiqué au chapitre "Utilisation du réfrigérateur" de ce manuel.
Trop de glace sur les parois et étagères du réfrigérateur.	La porte du congélateur ferme mal à cause d'un obstacle.	Veiller à la bonne fermeture des portes et les maintenir libres d'objets ou de saleté.
La lampe du réfrigérateur ne s'allume pas.	La fiche n'est pas connectée à la prise de courant.	Connecter la fiche.
	Le courant électrique n'arrive pas à la prise parce que le fusible est fondu ou parce que le limiteur automatique de puissance a sauté.	Changer le fusible ou reconnecter le limiteur automatique de puissance.
	La lampe n'est pas vissée à fond.	La visser correctement.
Fonctionnement bruyant.	La lampe est grillée.	Changer l'ampoule comme il est indiqué dans ce manuel.
	Le réfrigérateur n'a pas été nivelé correctement.	Niveler comme il est indiqué au chapitre "Installation" de ce manuel.
Bruit de barbotage	Cycle de fonctionnement.	Ne pas s'alarmer: ceci est tout à fait normal.
Les aliments se dessèchent.	Les aliments ne sont pas enveloppés ou recouverts.	Les envelopper ou l'introduire dans un récipient hermétique.
Il y a des odeurs à l'intérieur.	Un des aliments n'est pas enveloppé ou recouvert.	L'envelopper ou l'introduire dans un récipient hermétique.
	L'intérieur de l'appareil a besoin d'être nettoyé.	Nettoyer comme il est indiqué dans ce manuel.

## SERVICE D'ASSISTANCE TECHNIQUE

Si vous avez déjà réalisé les vérifications indiquées et votre problème persiste, NE REALISEZ AUCUNE AUTRE REPARATION VOUS-MEME. Mettez-vous en rapport avec le Service d'Assistance Technique le plus proche.

## SPECIFICATIONS

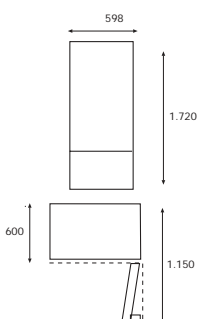
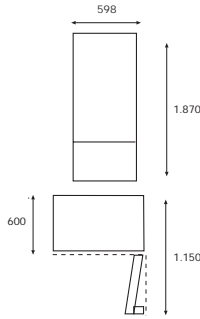
<p>• Dimensions (en mm)</p>		
-----------------------------	---	---

CE

CES APPAREILS RESPECTENT LES  
DIRECTIVES CEE: 73/23, 93/68, 89/336, 96/57

QUELFRIG.COM

# CONTENS

	Page
Installation .....	2
General Description.....	3
Starting up .....	4
Using the refrigerator.....	5
Using the freezer .....	7
Cleaning and Maintenance .....	11
Changing the direction of the doors .....	12
Panelling (P and PB models only) .....	14
Problems .....	15
Specifications.....	16

## WARNING

If your old refrigerator has a manual or automatic door locking device **DO NOT FORGET TO DESTROY OR INCAPACITATE THE LOCKING SYSTEM** before throwing it away, in order to prevent children from locking themselves inside whilst playing. **DO NOT DAMAGE THE PIPES** to avoid an uncontrolled leakage of coolant into the atmosphere.

## SAFETY

- The refrigerator model you have purchased is marketed with R600a or R134a refrigerants. You may check this by looking at the nameplate, and if your refrigerator uses R600a, remember that:
  - This refrigerant is not harmful to the environment.
  - It is inflammable, so make sure that the refrigerating circuit is in perfect condition. If it has suffered any damage, consult your dealer before switching on.
- This appliance may only be repaired by the after-sales service, using original replacement parts.
- Do not use elements with a flame or electrical appliances inside the refrigerator.
- Do not let children play with the appliance.
- Do not allow the lead to come in contact with the compressor.
- Make sure that the lead is not trapped under the appliance.
- To avoid damaging the environment and to contribute to recovering used materials, call your municipal collection service.



# INSTALLATION

## RECOMMENDATIONS

Allow air to circulate behind the refrigerator. Do not cover the front grill or top of the refrigerator with any object. If the refrigerator is placed underneath a cupboard, leave a space for air to circulate.

Your refrigerator's climate classification is stated on the specifications plate, and defines the room temperature range for which the cooling unit is designed, at which the apparatus is guaranteed to operate correctly. Where two classes are indicated, the unit will operate correctly in both.

Type	Temperature range
N	16° - 32°
ST	18° - 38°
T	18° - 43°

As far as possible avoid locating near to heat sources.

If the refrigerator needs to be laid down for unpacking or to change the direction of the doors, **ONLY LAY IT DOWN ON THE REAR SECTION.**

NOTE: The door hinges are on the right. If this is inconvenient the hinges can be changed to the other side. Instructions are contained in the section on changing the direction of door opening.

**IMPORTANT.** Ensure that the refrigerator is well seated on the ground (without movement) and is properly levelled (without tilting) by adjusting the levelling feet.

This refrigerator operates at 220/230 v. If the voltage in your home is different, a transformer should be used with an output of not less than 500 W. Use an **EARTHED** plug.

NOTE: The manufacturer will not accept any liability in the event that these recommendations are not followed.

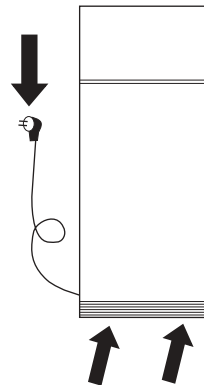
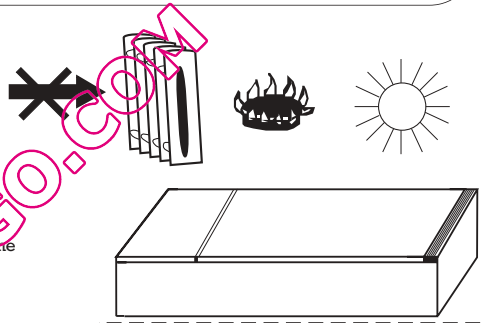

## BEFORE CONNECTING TO THE POWER

1.- Clean the inside of the refrigerator.



2.- Wait for 2 hours before connecting, to ensure proper functioning.



3.- Connect to the power.



# GENERAL DESCRIPTION

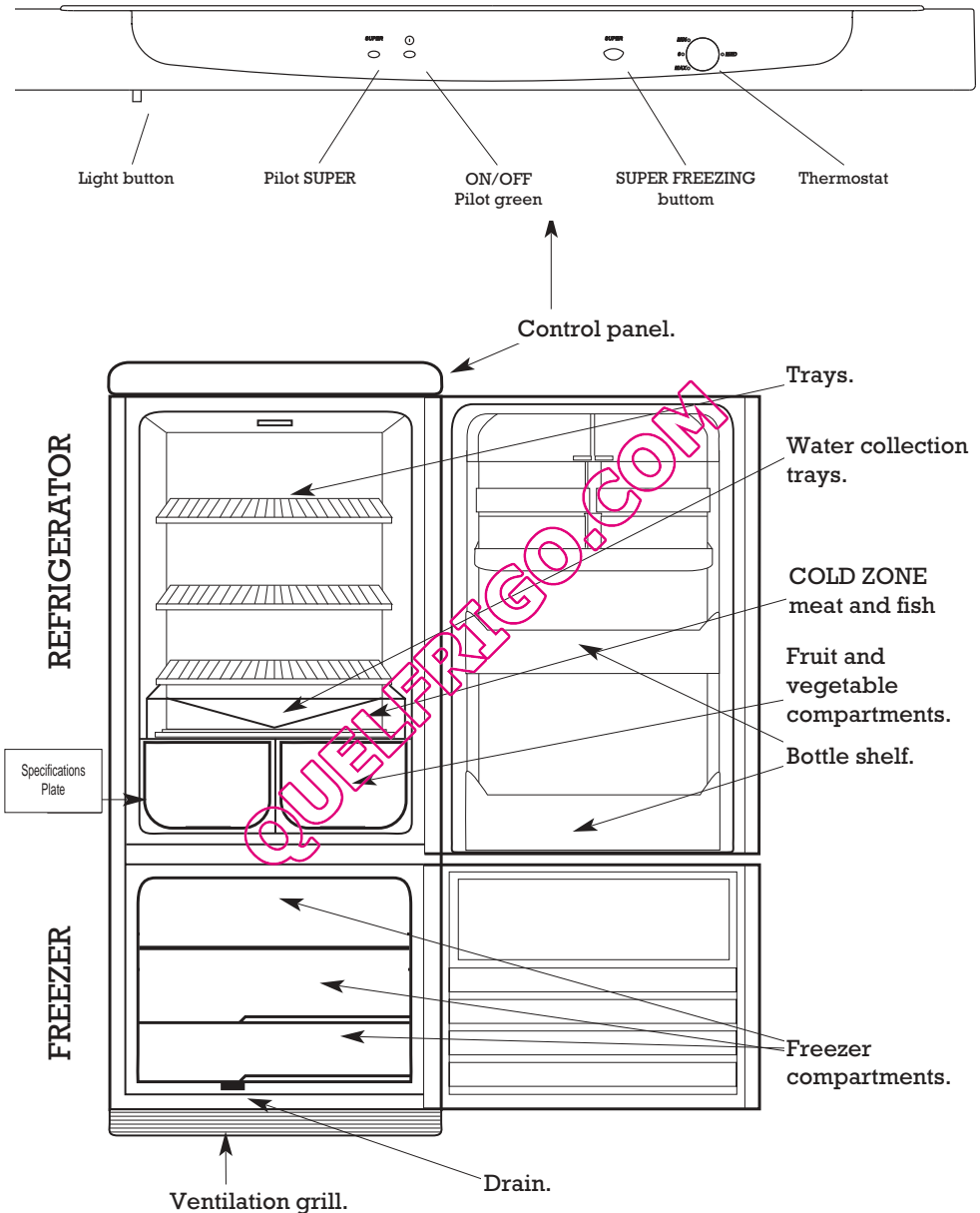

ENGLISH

# STARTING UP

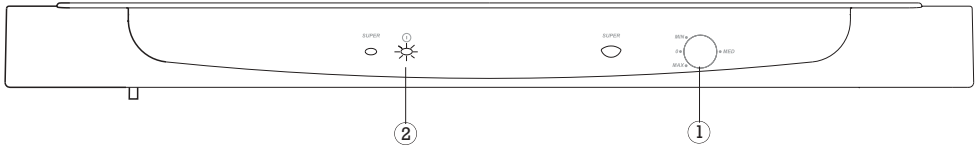

**1**

Turn the thermostat ① control clockwise to turn the pilot off ② and start the refrigerator.

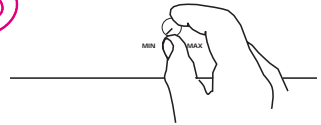

**2**

Turn the thermostat control to set the refrigerator to colder (MAX) or less cold (MIN). A middle setting is suggested initially.

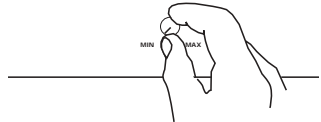

# USING THE REFRIGERATOR

## FOOD

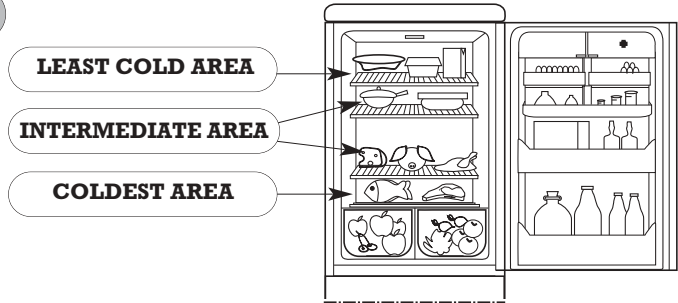

## ATTENTION

- The temperature inside the refrigerator can be selected by turning the thermostat control.
- Remember that the temperature is not totally uniform within the interior as a whole and different sections are more suitable for different types of food (as shown in the diagram).
- The temperature inside the refrigerator can be affected by the ambient temperature, the location of the refrigerator and the frequency with which the door is opened.
- Do not place uncovered liquids or hot food in the refrigerator.
- NEVER place volatile, inflammable or explosive liquids in the refrigerator, such as solvents, alcohols, acetone or petrol as there will be a risk of explosion.
- Meat and fish should be wrapped to avoid smells developing.

## MULTIFRESH SYSTEM

If your refrigerator has a Multifresh compartment:

- This guarantees **ideal conservation** of fresh food such as meat and fish, and also vegetables, allowing these items to be conserved for longer periods of time without having to freeze them.
- This area has the **coldest temperatures** in the refrigerator and is also the area least affected by frequent opening.
- For **meat and fish**, an intermediate refrigerator temperature is recommended.
- For **greater capacity** in the refrigerator, remove the top rack and cover, and store directly on the tray. This area loses the benefits outlined above.



# USING THE REFRIGERATOR

## DEFROSTING

The refrigerator has an automatic defrosting system and its is not therefore necessary to take any action.

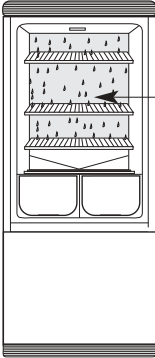

The back wall of the refrigerator is normally covered with drops of water or ice. This is completely **NORMAL** and is part of the automatic defrosting process.

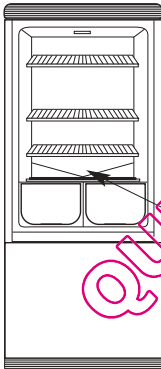

Periodically, or if the water collection channel is obstructed by dirt or foreign material, remove the cleaning cover, clean and replace it. This will prevent water from spilling outside the water collection channel.

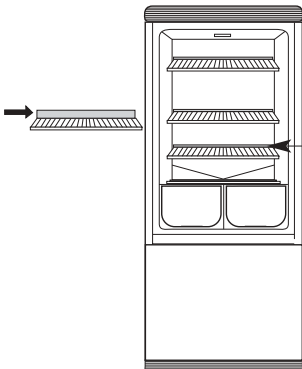

Ensure that foods does not touch the back wall. The trays have a limit point for this purpose which should not be exceeded.



# USING THE FREEZER

## FREEZING FRESH FOOD

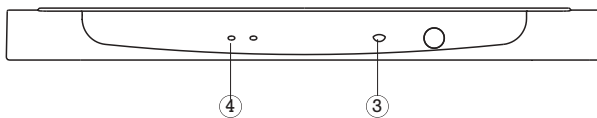

- 1 Place food to be frozen inside the freezer.

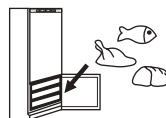

- 2 Press the superfreezing button, ③ (SUPER). The pilot light, ④, will light up.



- 3 24 hours later press the button ③, again to disconnect the superfreezing system. The pilot light ④, will go off. Your food will be properly frozen.



### NOTE

- The freezer of this refrigerator is rated with ★\*\*\* 4 stars in all of its compartments, and is capable of freezing the number of kilograms indicated on the specifications plaque within 24 hours.
- If you want to freeze quite a large number of food products at one go, you will achieve more efficient freezing by pressing the fast freezing button, so that the refrigerator maintains the right temperatures and they do not drop too low.

### ADVICE

- Wrap products to be frozen in aluminium foil or place them in sealed containers.
- Prepare foods in single consumption portions.
- Never refreeze food which has been defrosted.
- Label food with details of the contents and date frozen.
- Do not place food to be frozen in direct contact with food already frozen.
- Do not place fizzy drinks in the freezer section.
- Ice-cream, etc. should not be consumed at too low a temperature.

# DIRECTIONS FOR USE YOUR FREEZER

## FROZEN FOOD PRESERVATION

### A FEW HINTS

- When you buy frozen food in your shop, try to introduce the products into the freezer as soon as possible.
- Observe the preservation time that appear on the product packing, taking into account this a **★\*\*\*** freezer.
- When freezing food by yourself, consult the list of preservation times.

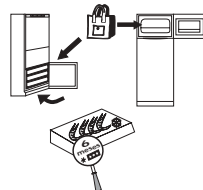

### CONSERVATION TIMES

SORT OF FOOD	Number of months
<b>FISH AND SHELLFISH</b>	
Lobsters	3
Shrimps	3
Cold	2
Sardines and similar	3/4
Trout	2/3
Salmon	2/3
Sole	3
Turbot	2/3
<b>MEAT</b>	
Beef	10/12
Mutton	6/8
Veal	9
Pork	6
Fillets/Chops	4
Liver/Kidneys	10
Brain/Tongue	2
Mincemeat, sausages	2
Rabbit	5/7
<b>POUTRY AND GAME</b>	
Chickens	10
Turkey (in portions)	7
Duck, goose	5
Hare	6
Partidrige-Quail	8
Pheasants	7/8
Big game	10
<b>READY TO SERVE FOOD</b>	
Tomato sauce	3
Stock	3
Beef, veal pork or chicken stews	2/3
Assorted vegetables	3
Stewed meat	3
Hamburguers	2
Stuffed peppers	2
Espinach	2
Brench beans	2
Tarts, confectionery, etc	5/6
Fruit salad	3
Sandwiches	6

SORT OF FOOD	Number of months
<b>VEGETABLES</b>	
Salt-wort	12
Artichoke	12
Carrots	12
Cauliflower	6/8
Brussels sprouts	6
Asparagus	12
Cabbage	6/8
Beans	12
Mushrooms	6
Parsley	12
Peppers	12
Spinach	12
Broad beans	12
<b>FRUITS</b>	
Apricots	8
Cherises, plums, raspberries, gooseberries, blackberries	10
Peaches	10/12
Strawberries	12
Stewed fruit (apples, pears)	10
Grapes	10/12
Fruit juices	10
Pineapple	10/12
<b>BREAD CONFECTIONERY</b>	
Biscuits-tarts	6
Flaky pastry tart	1
Pastry (unbaked)	3
Bread and rolls	2
<b>EGGS AND DAIRY PRODUCE</b>	
Eggs (shelled)	6
UHT Milk	3
Burter	6
Cheese (small portions)	6/8
Fresh cream	3

# USING THE FREEZER

## DEFROSTING FOOD

The same method should not be used for defrosting all types of food.

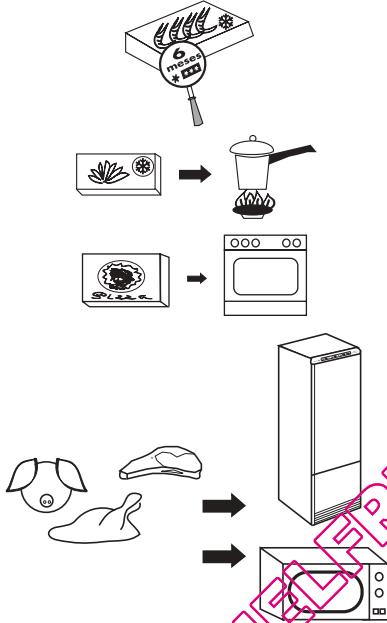

If you purchase frozen food from stores, follow the instructions on the packaging.

Green vegetables should be cooked without defrosting.

Pre-cooked and ready prepared food can generally be cooked without defrosting.

Meat and fish should be slowly defrosted in the refrigerator over several hours. If you have a microwave oven, defrosting can to a large extent be accelerated.

## MAKING ICE CUBES

- 1 Fill the trays inside the freezer three quarters full of water.



- 2 Place the trays in the freezer, preferably in the top section.

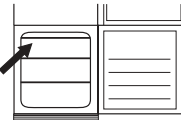

- 3 Once frozen, the ice cubes can be removed by gently twisting the trays.



# USING THE FREEZER

## DEFROSTING AND CLEANING

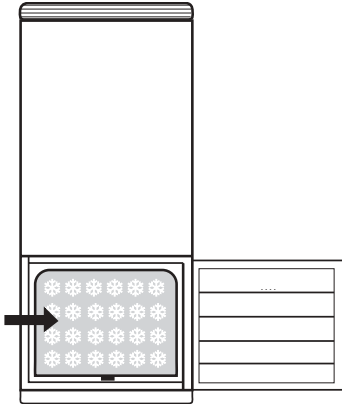

A layer of ice or frost will in time form on the walls of the freezer. This will lead to an increased power consumption. In order to avoid this, the layer of ice should be removed at least twice each year.

1

Turn the thermostat control anti-clockwise to turn the pilot light and the refrigerator off.

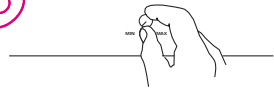

2

Remove frozen food, wrap it in newspaper and place it in the refrigerator as an excessive rise in temperature could reduce the food conservation period.

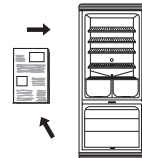

3

Leave the door open and unfold the flexible tab in the base of the freezer. Place one of the drawers, except for the bottom one, underneath it to collect the water. When finished, return the tab to its original position.

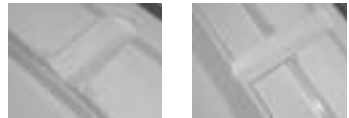

4

A scraper can be used to help remove the ice, or a container of hot water can be placed inside. Do not use sharp objects or electric heating devices.

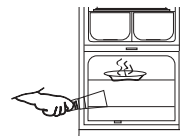

5

Dry the inside thoroughly.

6

Turn the thermostat control clockwise to turn the pilot light and freezer on.



7

Two hours later the frozen food can be replaced in the freezer.

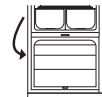

# CLEANING AND MAINTENANCE

## CLEANING

### ADVICE

The refrigerator should be disconnected before cleaning the inside.

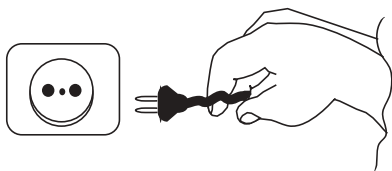

Do not use abrasive products, solvents, metal cleaning products or undiluted detergents.



Avoid cleaning the top with cloth which is excessively wet or spilling water onto the top part. This could damage the refrigerator.

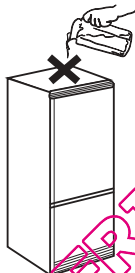

The grill on the rear part of the refrigerator should be cleaned once a year with a vacuum cleaner. Dirt will prevent proper functioning and increase electricity consumption.

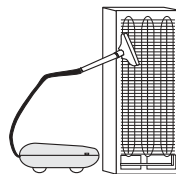

## TEMPORARILY TURNING OFF THE REFRIGERATOR

- Disconnect the refrigerator.
- Remove food and clean and dry the inside.
- Leave the door open to avoid the formation of offensive odours.
- Follow the same procedure in the event of a prolonged power cut or refrigerator breakdown.

## CHANGING THE BULB

1- Disconnect the refrigerator.

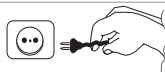

2- Remove the old bulb and replace with a similar type.

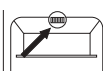

220 v  
15 w max.

E 14

## CHANGING THE DIRECTION OF DOOR OPENING

- 1 Remove the control panel casing by inserting the point of a screwdriver into the retaining grooves and exerting leverage until the rim is freed.

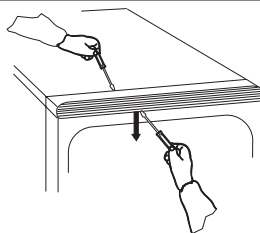

- 2 Remove the upper hinge after first removing the retaining screw. Grasp the upper door with both hands and remove it from the refrigerator.

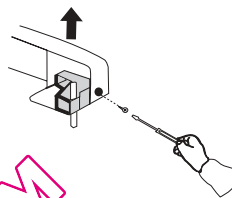

- 3 Remove the middle hinge by removing the protective plate which hides the screws, and after removing them, grasp the lower door with both hands and remove it from the refrigerator.

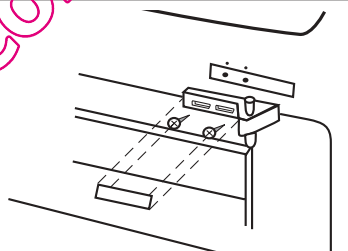

- 4 Remove the lower skirting as shown in the diagram. Then remove the left part of the skirting as shown to locate the lower hinge as shown in the diagram.

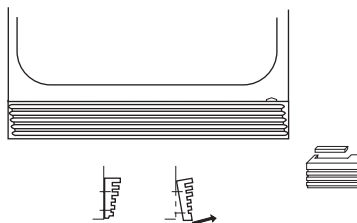

- 5 Remove the lower hinge by removing the 3 retaining screws (A). Remove the spindle (B) from the right-hand side position and insert it on the left hinge. Insert the lower hinge on the left after first removing the two screws (C).

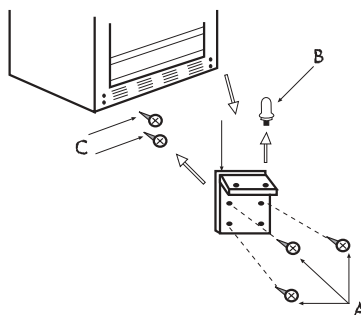

# CHANGING THE DIRECTION OF DOOR OPENING

- 6 Replace the lower skirting. Locate the lower door spindle and placing it on the lower hinge spindle.

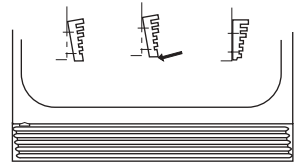

- 7 Remove the cover of the left-hand side lower door spindle and place it on the right-hand side (panellable models do not have this cover).

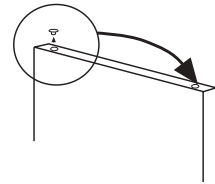

- 8 Insert the middle hinge on the left-hand side spindle of the lower door and screw it to the fridge, after first removing the protection covering the holes. Locate the upper part by placing it on the spindle of the middle hinge. Then, replace the protection plate that conceals the fixing screws.

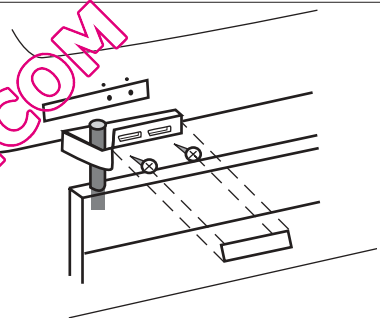

- 9 Insert the hinge in its seating on the left-hand part of the control panel and on the upper door simultaneously. Attach the hinge with the side screw.

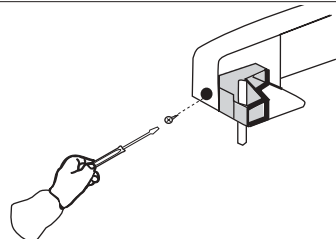

- 10 Replace the control panel casing by pressing the support until the retaining rim is fixed.

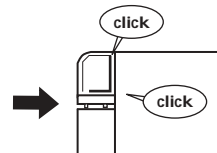

- 11 If you fridge accepts panels, the door handles should be changed from one side to the other.

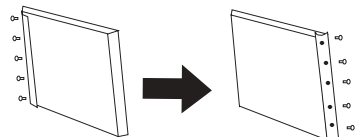

# PANELLING

In your refrigerator model accepts panels and you wish to give the outside of your fridge a similar appearance to the rest of your kitchen units, the doors can be covered with panels by following these instructions.

- 1** Dimensions of the refrigerator furniture and door panels.  
(Panel thickness less than 4 mm)

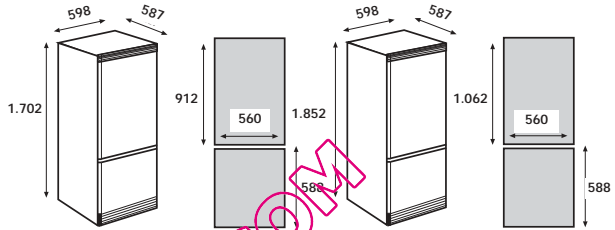

- 2** Remove the handle and/or frame from the left-hand side of the door by removing the corresponding screws.

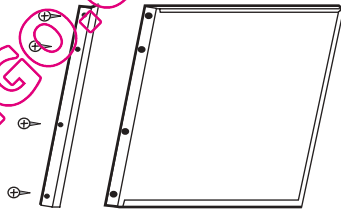

- 3** Loosen the remaining screws around the door, removing the frames as shown in the diagram and sliding the panel in.

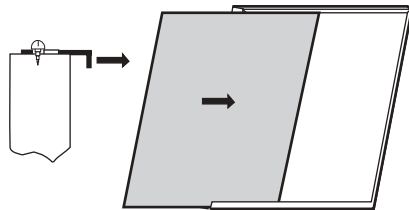

- 4** Hold the rim of the frame against the panel and insert the frame screws in that position. Locate the frame and/or the handle with their screws.

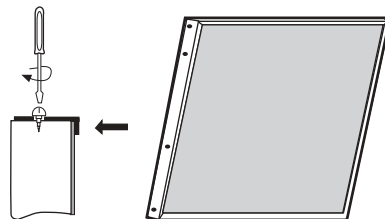



# PROBLEMS

PROBLEM	POSSIBLE REASON	SOLUTION
The refrigerator is not working	The plug is not properly connected to the power supply.	Connect the plug.
	Electricity is not reaching the plug because a fuse has blown or an automatic circuit breaker has opened.	Change the fuse or reset the automatic circuit breaker.
The refrigerator does not get properly cold	The thermostat is set too low.	Turn the thermostat to a colder position.
	The door has not been closed properly or is opened too often.	Ensure that the door does not remain open for too long.
	The ventilation grill or the opening to the rear of the rear part of the refrigerator has been obstructed.	Keep these areas free as indicate in the Installation section of this manual.
	The refrigerator is in direct sunlight or exposed to a heat source.	Change the location of the refrigerator or protect it from heat sources.
Drops of water on the rear wall of the refrigerator	Automatic defrosting cycle.	Do not worry -this is completely normal (see section on Using the Refrigerator in this manual).
Water shows up of the bottom of the refrigerator	Food or a container has been placed in contact with the rear wall of the refrigerator.	Do not place food or containers in contact with the rear wall to avoid spillage of water formed when defrosting.
	The refrigerator drain is obstructed.	Unblock the drain with the cleaning cover as shown in the section on Using the Refrigerator in this manual.
A large amount of ice forms on the walls and shelves of the freezer	The freezer door is obstructed and does not close properly.	Make sure that doors close properly by keeping them free from dirt and obstructions.
The refrigerator light does not come on	The plug is not properly connected to the power supply.	Connect the plug.
	Electricity is not reaching the plug because a fuse has blown or an automatic circuit breaker has opened.	Change the fuse or reset the automatic circuit breaker.
	The bulb is loose.	Insert properly.
	The bulb has blown.	Change the bulb as indicated in this manual.
Noisy operation	The refrigerator has not been properly levelled.	Level the refrigerator as indicated in the Installation section of this manual.
A bubbling noise	Operating cycle.	Do not worry -this is completely normal.
Food dries out	Food is not wrapped or placed in a container.	Wrap or place food in sealed containers.
Unpleasant smell inside the refrigerator	Food is not properly wrapped or in a container.	Wrap food or place it in a sealed container.
	The inside of the refrigerator needs cleaning.	Clean the refrigerator as shown in this manual.

## TECHNICAL SERVICE

If you have carried out the above checks and the problem persists DO NOT CARRY OUT ANY REPAIRS YOURSELF.

Contact your nearest Technical Service.

## SPECIFICATIONS

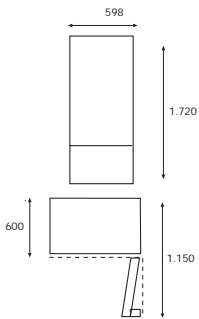
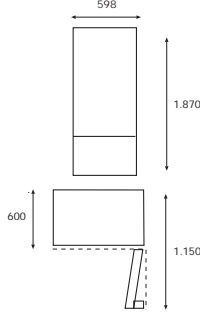
<p>• Dimensions (in mm)</p>		
-----------------------------	---	---



THESE APPLIANCES MEET  
EEC DIRECTIVES: 73/23, 93/68, 89/336, 96/57

QUELFRIGO.COM

# INHALT

	Seite.
Installierung .....	2
Allgemeine Beschreibung .....	3
Inbetriebnahme .....	4
Benutzung des Kühlteils .....	5
Benutzung des Gefrierteils .....	7
Reinigung und Wartung .....	11
Wechsel des Türanschlags .....	12
Dekorverkleidung (nur bei den modellen P und PB) ....	14
Betriebsstörungen .....	15
Technische Daten .....	16

## ACHTUNG

Wenn Ihr alter Kühlschrank mit automatischen oder manuellen Verriegelungsklinken ausgestattet ist, **VERGESSEN SIE NICHT DIE VERRIEGELUNG ZU VERNICHTEN ODER UNBRAUCHBAR ZU MACHEN**, bevor Sie ihn zum Sperrmüll geben. So wird verhindert, daß Kinder sich beim Spielen einschließen. **DIE ROHRE NICHT BESCHÄDIGEN**, um ein ungesteuertes Entweichen von Kühlmittel zu vermeiden.

## SICHERHEIT

- Das von Ihnen erworbene Kühlschrankmodell wird mit den Kühlmitteln R600a oder R134a vertrieben. Sie können dies auf dem Typenschild feststellen, und wenn Ihr Kühlschrank R600a verwendet, beachten Sie bitte:
  - Dieses Kühlmittel ist umweltfreundlich.
  - Es ist entflammbar, weshalb Sie sich versichern sollten, dass Ihr Kühlschrank sich in einwandfreiem Zustand befindet. Falls er beschädigt sein sollte, wenden Sie sich an Ihren Händler, bevor Sie ihn anschliessen.
- Dieses Gerät darf nur vom Kundendienst unter Verwendung von Originalersatzteilen repariert werden.
- Keine Elemente mit Feuer oder Elektrogeräte im Geräteinneren verwenden.
- Das Gerät ist nicht zum Spielen für Kinder geeignet.
- Achten Sie darauf, dass das Kabel nicht mit dem Kompressor in Berührung kommt.
- Achten Sie darauf, dass das Kabel nicht unter dem Gerät eingeklemmt wird.
- Lassen Sie das Gerät von der städtischen Abfallentsorgung abholen, um Umweltbeeinträchtigungen zu vermeiden und die einzelnen Bestandteile der Wiederverwertung zuzuführen.



# INSTALLIERUNG

## EMPFEHLUNGEN

Einen Luftumlauf auf der Rückseite des Kühlschranks ermöglichen. Weder das Vorgitter noch die Kühlschrankdecke mit Gegenständen abdecken. Wenn ein Schrank über dem Gerät angebracht wird, muß zur Belüftung ein Freiraum gelassen werden.

Die Klimakategorie Ihres Kühlschranks ist im Typenschild angegeben.

Sie bestimmt den Raumtemperaturbereich, für den der Kühlschrank vorgesehen und in welchem ein einwandfreier Betrieb gewährleistet ist.

Werden beide Kategorien angegeben, ist ein einwandfreier Betrieb unter den Voraussetzungen beider Kategorien gewährleistet.

Kategorie:	Raumtemperaturen
N	16° bis 32°
ST	18° bis 38°
T	18° bis 43°

Möglichst die Nähe von Hitzequellen meiden.

Wenn der Kühlschrank zum Auspacken oder zum Wechseln des Türanschlags hingelegt werden muß, **NUR AUF DIE RÜCKSEITE LEGEN**.

ANMERKUNG: die Türscharniere sind auf der rechten Seite angebracht. Wenn diese Stelle unbequem für Sie ist, können die Scharniere auf der anderen Seite angebracht werden. Im Anhang SEITENWECHSEL DER TÜROFFNUNG befindet sich die Anleitung dazu.

Durch Einstellen der Nivellierfüße ist sicherzustellen, daß der Kühlschrank gut (ohne zu hinken) und eben (nicht seitlich geneigt) auf der Stellfläche steht. **WICHTIG**.

Dieser Kühlschrank wird bei 220/230 V betrieben. Wenn die im Haus zur Verfügung stehende Spannung eine andere ist, muß eine Leistungstransformator mit einer Leistung von mind. 500 W verwendet werden. Verwenden Sie einen ERDANSCHLUSS.

ANMERKUNG: Der Hersteller lehnt jede Haftung ab, wenn diese Empfehlungen nicht beachtet werden.

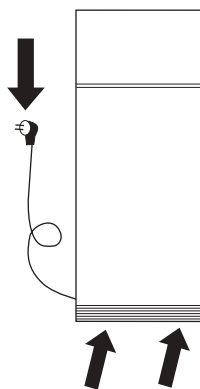
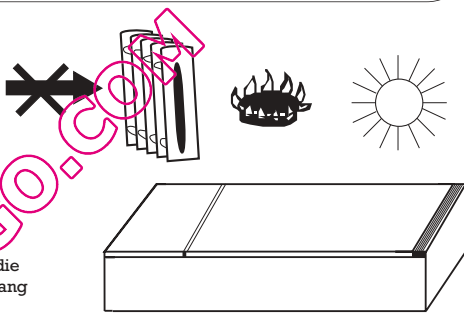

## ACHTUNG: VOR DEM ANSCHLIESSEN

1.- Den Kühlschrank innen reinigen.



2.- Für einen einwandfreien Betrieb, erst nach Ablauf von 2 Stunden anschließen.



3.- Anschließen.



# ALLGEMEINE BESCHREIBUNG

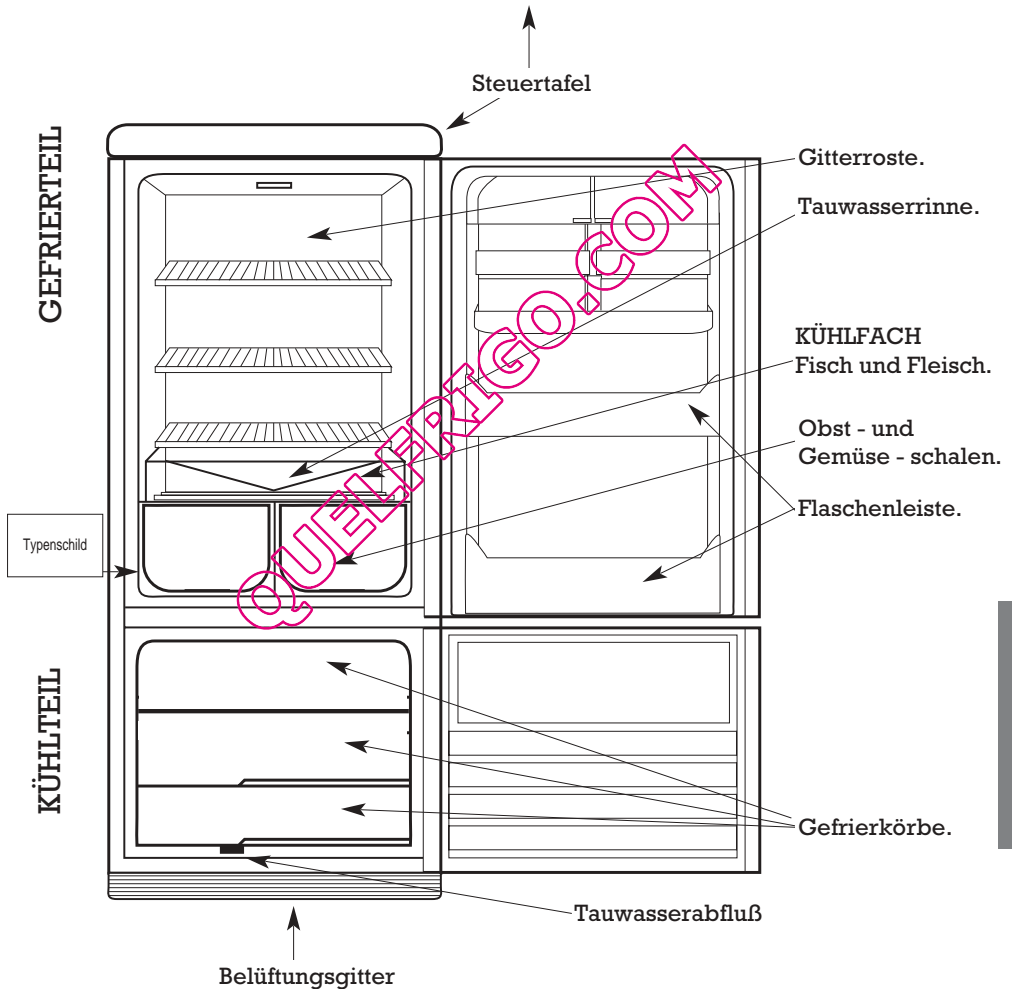
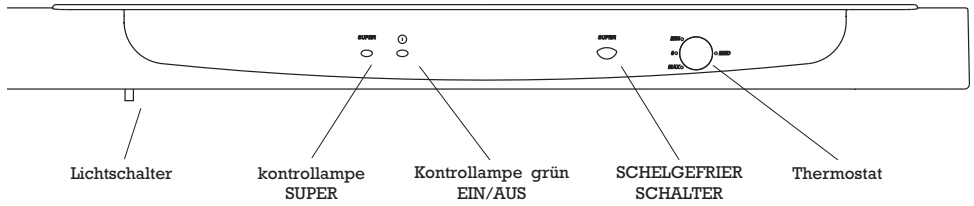

DEUTSCH

# INBETRIEBNAHME

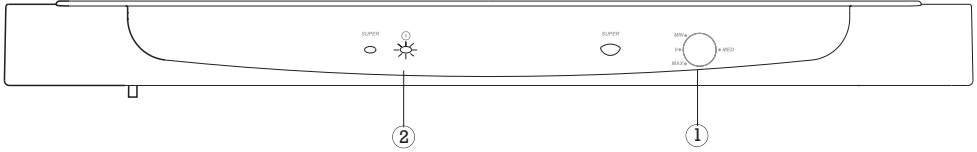

**1**

Thermostatschalter ① im Uhrzeigersinn drehen. Die Leuchtanzeige ② geht an und das Kühlabteil wird eingeschaltet.



**2**

Durch Drehen des Thermostatschalters wird im Kühlabteil eine höhere (MAX) oder geringere (MIN) Kühltemperatur eingestellt. Es ist empfehlenswert, anfangs eine mittlere Stellung zu wählen.



# BENUTZUNG DES KÜHLTEILS

## LEBENSMITTEL

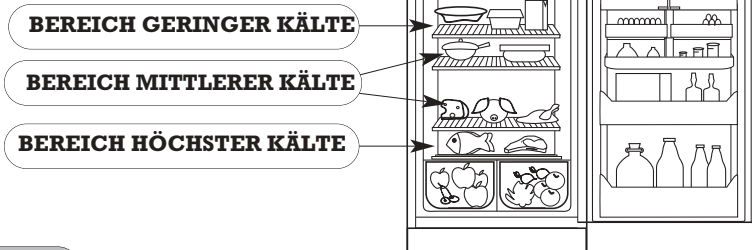

## ACHTUNG

- Durch Drehen des Thermostatreglers kann eine stärkere oder schwächer Kühlung des Kühlteils eingestellt werden.
- Es ist zu beachten, daß nicht im ganzen Kühlraum die gleiche Temperatur herrscht, so daß es für jede Lebensmittelart einen entsprechenden Bereich gibt (siehe Abbildung).
- Die Kühlraumtemperatur kann durch die Raumtemperatur, die Aufstellung des Geräts und die Häufigkeit des Türöffnens beeinträchtigt werden.
- Keine heißen oder nicht verschlossenen flüssigen Lebensmittel ins Kühlteil einführen.
- NIEMALS flüchtige, entzündbare oder explosive Flüssigkeiten, wie Lösungsmittel, Alkohole, Aceton oder Benzin in den Kühlraum einführen. Explosionsgefahr.
- Fleisch und Fisch sollte verpackt werden, um Geruchsbildung zu vermeiden.

## MULTIFRESH-SYSTEM

Ihr Kühlschrank verfügt über ein Multifresh-Abteil:

- **Ideale Konservierung** frischer Nahrungsmittel wie Fleisch, Fisch und Gemüse. Diese können längere Zeit ohne Einfrieren aufbewahrt werden.
- In diesem Abteil herrschen die **kältesten Temperaturen** des Kühlabteils; ausserdem wird es durch das häufige Öffnen der Tür weniger beeinträchtigt.
- Zum Aufbewahren von **Fisch und Fleisch** sollte eine mittlere Temperatur gewählt werden.
- Ist **mehr Platz** im Kühlabteil gewünscht, obere Ablage und Deckel herausnehmen und Nahrungsmittel direkt in der Mulde lagern. Das Abteil verliert dadurch die zuvor beschriebenen Eigenschaften.



# BENUTZUNG DES KÜHLTEILS

## ABTAUEN

Das Abtauen des Kühlteils erfolgt automatisch, also ohne jegliches Eingreifen des Benutzers.

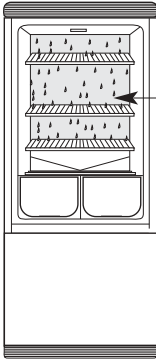

Die Rückenwand des Kühlteils ist gewöhnlich mit kleinen Wassertropfen oder Eis bedeckt. Das ist vollkommen **NORMAL** und gehört zum Ablauf Abtauautomatik.

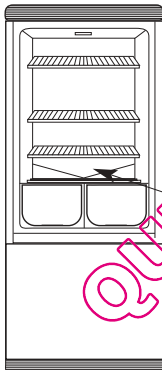

Oder wenn die Tauwasserablauffrinne durch Verschmutzung oder irgendeinen Gegenstand verstopft ist

So wird das Überlaufen der Tauwasserablauffrinne verhindert.

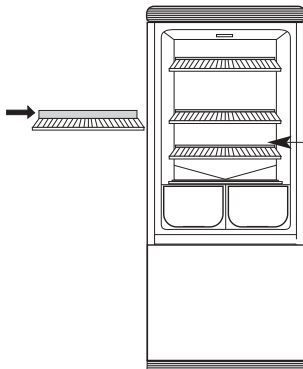

Die Lebensmittel sollten möglichst nicht mit der Rückenwand in Berührung kommen. Dazu sind die Gitterroste mit einem Anschlag versehen der nicht überschritten werden sollte.



# BENUTZUNG DES GEFRIERTEILS

## EINFRIEREN VON FRISCHKOST

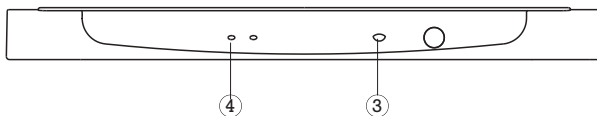

- 1** Die Lebensmittel in den Gefrierraum geben.

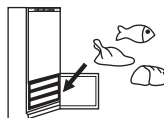

- 2** Den Schellgefrierschalter ③ (SUPER) betätigen. Die Kontrolllampe ④ leuchtet auf.



- 3** Nach 24 Stunden zum Abschalten, Schalter ③ wieder betätigen, Die Kontrolllampe ④ geht wieder aus. Ihre Lebensmittel sind nun fertig gefroren.



## ANMERKUNG

- Der Gefrierschrank dieses Kühlschranks hat in allen Gefrierfächern **★\*\*\* 4-Sterne-Kategorie**. Er friert das auf dem Leistungsschild angegebene Kg-Gewicht an Gefriergut in 24 Std. ein.
- " Wollen Sie in einem einzigen Prozess eine grössere Menge von Nahrungsmitteln einfrieren, dann erzielen Sie ein besseres Gefrierergebnis, wenn Sie vorher die Taste für einen 24-stündigen Schnellgefriervorgang drücken, womit im Kühlschrank geeignete Temperaturen beibehalten werden und eine übermässige Kühlung ausgeschlossen ist."

## TIPS

- Die einzufrierenden Produkte in Alufolie oder luftdichte Behälter verpacken.
- Die Lebensmittel in Rationen für den einmaligen Verbrauch zubereiten.
- Niemals bereits aufgetaute Lebensmittel wieder einfrieren.
- Ein Schild, mit Inhalt und Einfrierdatum an der Verpackung anbringen.
- Die einzufrierenden Lebensmittel mit den bereits gefrorenen nicht in Berührung bringen.
- Keine kohlenensäurehaltigen Getränke im Gefrierfach aufbewahren.
- Speiseeis sollte nicht zu kalt verbraucht werden.

# BENUTZUNG DES GEFRIERTEIL

## KONSERVIERUNG TIEFGEKÜHLTER NAHRUNGSMITTEL

### EMPFEHLUNGEN

- Wenn Sie tiefgekühlte Nahrungsmittel einkaufen, sorgen Sie dafür, dass die Pakete so schnell wie möglich in Ihren Gefrierfach kommen, damit sie nicht antauen.
- Achten Sie auf die auf der Verpackung der Tiefkühlkost angegebenen Konservierungszeit und bedenken Sie, dass dies ein ★ \*\*\* Gefrierfach ist.
- Wenn Sie Ihre selbstgekochten Speisen einfrieren wollen, beachten Sie bitte die Tabelle mit den Konservierungszeiten.

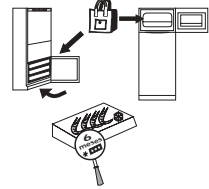

### KONSERVIERUNGSZEITEN

#### ART DER NAHRUNGSMITTEL Monate

FISCH UND MEERESFRÜCHTE	
Languste-Krustentiere	3
Krevetten-Garnelen	3
Seehecht	2
Fette Fischarten	3/4
Forelle	2/3
Lachs	2/3
Seezunge	3
Steinbutt	2/3
FLEISCH	
Rindfleisch	10/12
Hammelfleisch	6/8
Kalbfleisch	9
Schweinefleisch	6
Koteletts, Steaks	4
Leber/Nieren	10
Hirn/Zunge	2
Hackfleisch, Würstchen	2
Kaninchen	5/7
GEFLÜGEL UND WILD	
Huhn-Hähnchen	10
Truthahn (zerteilt)	7
Ente, Gans,	5
Hase	6
Rebhuhn, Wachtel,	8
Fasan	7/8
Damhirsch, Hochwild	10
FERTIGE SPEISEN	
Tomatensoße	3
Fleischbrühe	3
Braten vom: Ochsen, Kalb, Hähnchen, Schwein	2/3
Gemischtes Gemüse	3
Gekochtes od. geschmortes Fleisch	3
Frikadellen	2
Gefüllte Paprikaschoten	2
Spinat	2
Grüne Bohnen, gekocht und sautiert	2
Pasteten, Torten usw	5/6
Obstsalat	3
Belegte Brote	6

#### ART DER NAHRUNGSMITTEL Monate

GEMÜSE	
Mangold	12
Artischocken	12
Karotten	12
Blumenkohl	6/8
Rosenkohl	6
Spargel	12
Weißkohl	6/8
Grüne Bohnen	12
Pilze	6
Petersilie	12
Paprikaschoten	12
Spinat	12
Große Bohnen	12
OBST	
Aprikosen	8
Kirschen, Pflaumen, Himbeeren, Johannisbeeren, Brombeeren	10
Pfirsiche	10/12
Erdbeeren	12
Kompott (Äpfel, Birnen)	10
Weintrauben	10/12
Obstsaft	10
Ananas	10/12
BROT UND GEBÄCK	
Biscuit-Torten	6
Blätterteigtorte	1
Teig	3
Brot und Hefengebäck	2
EIER, MILCH UND MILCHPRODUKTE	
Eier (ohne Schale)	6
Homogenisierte Milch (Kartonverpackung)	3
Butter	6
Käse (kleine Portionen)	6/8
Frische Sahne	3

# BENUTZUNG DES GEFRIERTEILS

## AUFTAUEN VON LEBENSMITTELN

Nicht alle Lebensmittel sind in gleicher Weise aufzutauen.

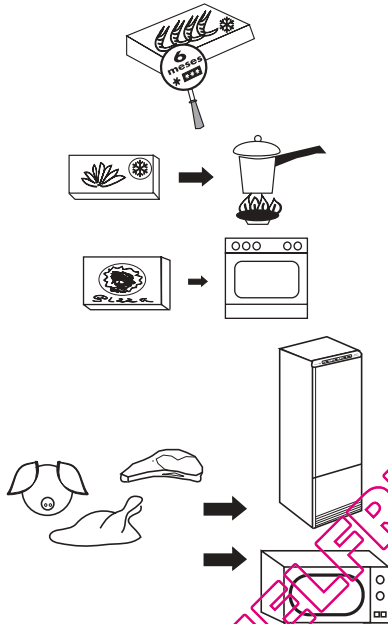

Wenn das Gefrierprodukt aus einem Geschäft stammt, befolgen Sie die Packungshinweise.

Gemüse wird direkt gegart.

Ganz allgemein können zubereitete oder vorgekochte Produkte direkt gegart werden.

Fleisch und Fisch müssen mehrere Stunden im Kühlschrank langsam aufgetaut werden. Wenn ein Mikrowellenherd vorhanden ist, kann das Auftauen erheblich verkürzt werden.

## HERSTELLUNG VON EISWÜRFELN

- 1 Die im Innern des Gefrierteils befindlichen Eiswürfelschalen zu drei Vierteln mit Wasser anfüllen.
- 2 Die Eiswürfelschalen in das Gefrierteil, vorzugsweise in den oberen Teil desselben, einführen.
- 3 Nachdem das Wasser gefroren ist, können die Eiswürfel durch ein leichtes Verdrehen der Schalen herausgenommen werden.

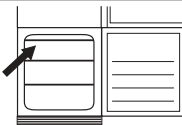

# BENUTZUNG DES GEFRIERTEILS

## ABTAUEN UND REINIGUNG

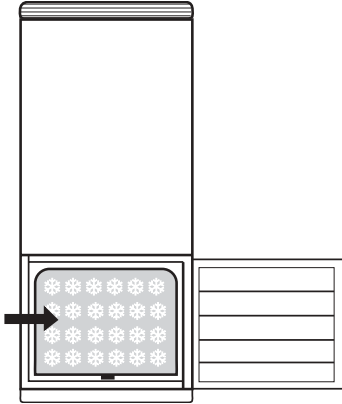

Mit der Zeit bildet sich an den Wänden des Gefriererteils eine Eis- bzw. Reifschicht.

Dies führt zu einem höherem Energieverbrauch Ihres Kühlschranks.

Um dies zu vermeiden, muß diese Eisschicht mindestens 2 Mal im Jahr entfernt werden.

- 1** Thermostatschalter gegen den Uhrzeigersinn drehen. Die Leuchtanzeige erlischt und das Kühlabteil wird ausgeschaltet.



- 2** Das Gefrierergut herausnehmen, in Zeitungspapier verpacken und in den Kühlschrank legen, da ein zu starker Temperaturanstieg der Lebensmittel ihre Haltbarkeit verringern könnte.

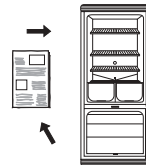

- 3** Tür Öffnen und die im Boden des Gefrierabteils eingerasstete elastische Lasche umbiegen. Eine der Schubladen, mit Ausnahme der untersten, darunterstellen, um das Wasser aufzufangen. Nach Beendigung des Vorgangs die Lasche wieder in die ursprüngliche Stellung zurückbiegen.

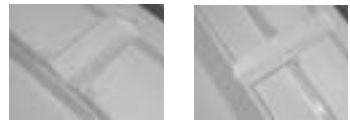

- 4** Zur Eisentfernung kann mit Hilfe der Schaufel oder durch das Hineinstellen eines Behälters mit heißem Wasser nachgeholfen werden. Keine scharfen Gegenstände oder elektrischen Heizgeräte verwenden.

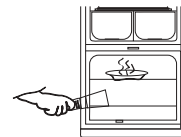

- 5** Innen gut abtrocknen.

- 6** Thermostatschalter im Uhrzeigersinn drehen. Die Leuchtanzeige geht an und das Kühlabteil wird eingeschaltet.

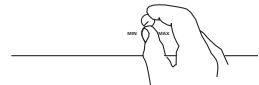

- 7** Nach 2 Stunden können Sie das Gefrierergut wieder ins Gefriererteil geben.



# REINIGUNG UND WARTUNG

## REINIGUNG

### EMPFEHLUNGEN

Zur Reinigung des Kühlschranks von innen, muß er ausgeschaltet sein.

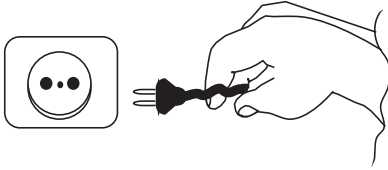

Verwenden Sie keine ätzenden Lösungsmittel, Metallreinigungsmittel oder unverdünnte Reinigungsmittel verwenden.

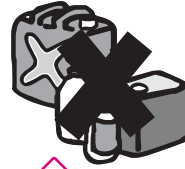

Decke nicht mit Wasser oder zu nassem Tuch reinigen. Das könnte den Kühlschrank beschädigen.

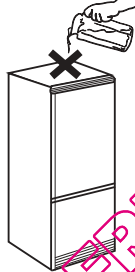

Einmal im Jahr sollte der Gitterrost auf der Rückseite des Kühlschranks mit dem Staubsauger gereinigt werden. Eine Verschmutzung beeinträchtigt den Betrieb und erhöht den Stromverbrauch.

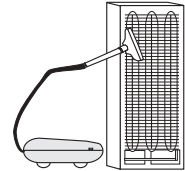

### VORÜBERGEHENDS AUSSETZEN DES BETRIEBS

- Kühlschrank abschalten.
- Die Lebensmittel herausnehmen, innen gut reinigen und abtrocknen.
- Die Tür offen lassen, um einer Geruchsbildung vorzubeugen.
- Dasselbe ist bei längeren Stromausfällen oder Betriebsstörungen des Kühlschranks zu befolgen.

### LAMPENWECHSEL

1- Kühlschrank abschalten.

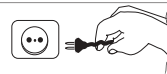

2- Die durchgebrannte Glühbirne herausnehmen und durch eine andere desselben Typs ersetzen.

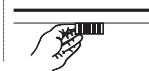
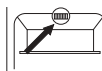

220 v  
15 w max.

# WECHSEL DES TÜRANSCHLAGS

1

Das Gehäuse der Steuertafel durch Einführen eines Schraubenziehers in die Befestigungsfuge und das Freilegen der Falze mit Hilfe der Hebelwirkung, herausnehmen.

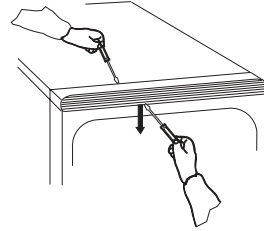

2

Das obere Scharnier durch vorheriges Lösen der Feststellschraube herausnehmen. Die obere Tür mit beiden Händen festhalten und abnehmen.

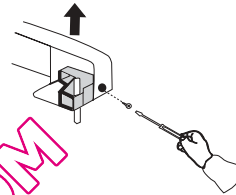

3

Das mittlere Scharnier durch Entfernen des Schutzplättchens, das die Schrauben verdeckt, und das Lösen dieser Schrauben, herausnehmen. Die untere Tür mit beiden Händen festhalten und abnehmen.

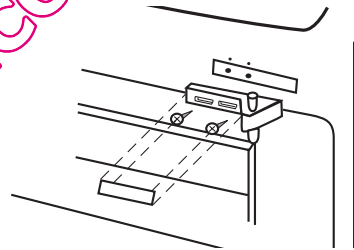

4

Den unteren Sockel wie auf der Abbildung gezeigt herausnehmen. Anschließend die markierte linke Seite des Sockels aufritzen und das untere Scharnier gemäß der Abbildung einsetzen.

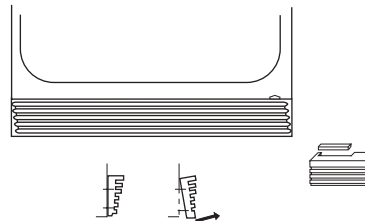

5

Das untere Scharnier durch Lösen der 3 Feststellschrauben (A) herausnehmen. Lösen Sie die Achse (B) aus der rechten Position und bringen Sie dieselbe in die linke Position der Scharniere. Das untere Scharnier nach vorherigem Lösen der 2 Schrauben (C) auf der linken Seite einsetzen.

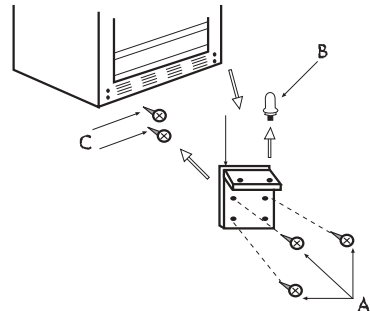

# WECHSEL DES TÜRANSCHLAGS

- 6** Die unteren Sockel an derselben Stelle wieder einsetzen. Die untere Tür durch Einführen in die Achse des unteren Scharniers einsetzen.

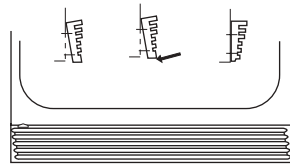

- 7** Die Abdeckung der linken Achse der unteren Tür entfernen und auf die rechte Achse setzen (bei den Modellen verkleidbaren ist keine Abdeckung vorhanden).

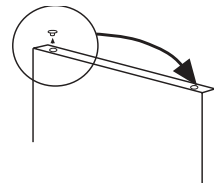

- 8** Das mittlere Scharnier in die linke Achse der unteren Tür einsetzen und nach dem Entfernen der Öffnungsschützer \* an den Kühlschrank festschrauben. Das obere Teil durch Einführen in die Achse des mittleren Scharniers anbringen. Stecken Sie anschliessend die Schutzplatte auf, welche die Befestigungsschrauben abdeckt.

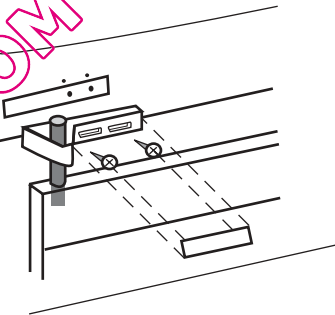

- 9** Das Scharnier gleichzeitig in ihr Lager auf der linken Seite der Steuertafel und in der Achse der oberen Tür einführen. Das Scharnier mit der Seitenschraube befestigen.

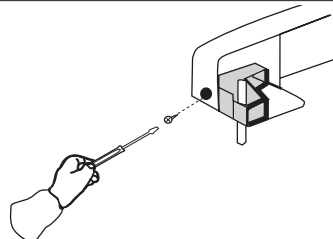

- 10** Das Gehäuse der Steuertafel durch Andrücken auf die Unterlage bis zum Einhaken der Befestigungsansätze \* anbringen.

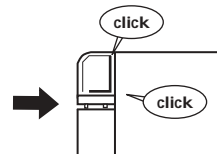

- 11** Wenn Ihr Kühlschrank mit einem Panel überziehbar ist, sollten Sie den die Türgriffe wechseln.

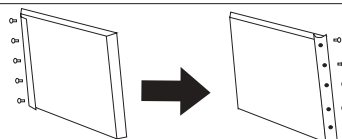

# DEKORVERKLEIDUNG

Wenn Ihr Kühlschrank ein dekorfähiges Modell ist und Sie sein äußeres Erscheinungsbild den restlichen Küchenmöbeln anpassen wollen, können Sie die Türen, den folgenden Anweisungen folgend, mit Paneelen verkleiden.

1

Abmessungen des Kühlschrankmöbels.  
(Wandstärke der Paneele unter 4 mm).

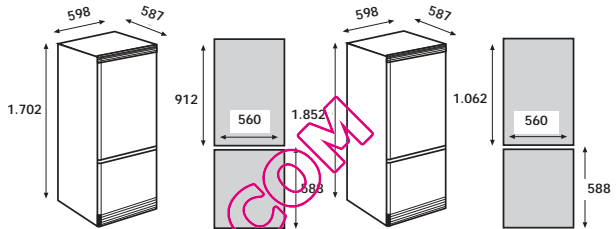

2

Den Griff und/oder Rahmen auf der linken Seite der Tür durch Lösen der entsprechenden Schrauben entfernen.

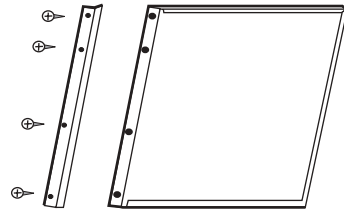

3

Die restlichen Schrauben des Türrahmens lockern und die Rahmen, wie in der Abbildung gezeigt, abnehmen und das Paneel hineingleiten lassen.

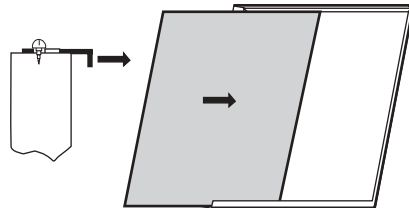

4

Den verstärkten Rand des Rahmens gegen das Paneel andrücken und die Rahmenschrauben in dieser Position einschrauben. Den Rahmen und/oder den Griff mit den jeweiligen Schrauben befestigen

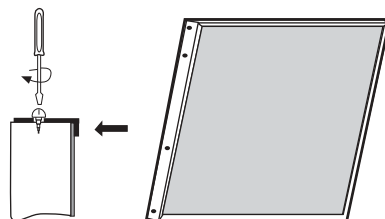



# BETRIEBSSTÖRUNGEN

STÖRUNG	MÖGLICHE URSACHE	LÖSUNG
Der Kühlschrank funktioniert nicht	Der Stecker ist nicht ans Netz angeschlossen.	Stecker anschließen.
	Es gelangt kein Strom an den Anschluß, weil die Sicherung durchgebrannt, oder der automatische Leistungsbegrenzer herausgesprungen ist.	Sicherung auswechseln oder automatischen Leistungsbegrenzer wieder anschließen.
Der Kühlschrank kühlt schlecht	Die Thermostatsteuerung ist zu niedrig gestellt.	Den Thermostatregler auf kältere Einstellung drehen.
	Die Tür ist nicht richtig verschlossen gewesen oder ist häufig geöffnet worden.	Darauf achten, daß die Tür nicht lange offen bleibt.
	Belüftungsrost oder hintere Deckenöffnung behindert.	Diese Bereiche, gemäß den Angaben von Kapitel "Installation" dieser Bedienungsanleitung, freihalten.
Der Kühlschrank ist direkter Sonnenstrahlung oder einer Hitzequelle ausgesetzt.	Der Kühlschrank ist direkter Sonnenstrahlung oder einer Hitzequelle ausgesetzt.	Den Kühlschrank an einen anderen Ort stellen oder ihn vor diesen Hitzequellen schützen.
	Automatischer Abtaukreislauf.	Kein Grund zur Besorgnis: das ist vollkommen normal (siehe Kapitel "Benutzung des Kühlteils" dieser Bedienungsanleitung).
Wassertropfen auf der Rückenwand des Kühlschranks	Automatischer Abtaukreislauf.	Kein Grund zur Besorgnis: das ist vollkommen normal (siehe Kapitel "Benutzung des Kühlteils" dieser Bedienungsanleitung).
Es erscheint Wasser auf dem Boden des Kühlschranks	Es ist irgendein Lebensmittel oder Behälter direkt an der Rückenwand aufbewahrt worden.	Keine Lebensmittel oder Behälter direkt mit der Rückenwand in Berührung bringen. So wird das Ausfluß von Tauwasser vermieden.
	Der Tauwasserablauf des Kühlschranks ist verstopft.	Den Tauwasserablauf mit Hilfe des Stöpsels befreien, wie im Kapitel "Benutzung des Kühlschranks" dieser Bedienungsanleitung beschrieben.
Größere Einsmengen an den Kühlschrankwänden und-fächern	Die Tür des Gefrierteils ist versperrt und schließt nicht richtig.	Sorgen Sie für ein richtiges Abschließen der Tür durch Freihalten von Gegenständen oder Verschmutzung.
Die Kühlschranklampe leuchtet nicht auf	Der Stecker ist nicht ans Netz angeschlossen.	Stecker anschließen.
	Es gelangt kein Strom an den Anschluß, weil die Sicherung durchgebrannt oder der automatische Leistungsbegrenzer herausgesprungen ist.	Sicherung auswechseln oder automatischen Leistungsbegrenzer wieder anschließen.
	Die Glühbirne sitzt locker.	Richtig einschrauben.
Geräuschvoller Betrieb	Die Birne ist ausgebrannt.	Glühbirne auswechseln, wie in dieser Bedienungsanleitung beschrieben.
	Der Kühlschrank ist nicht richtig höhen eingestellt.	Einstellen, gemäß den Hinweisen im Kapitel "Installation" dieser Bedienungsanleitung.
Brodelergeräusch	Betriebskreislauf.	Kein Grund zur Besorgnis, das ist vollkommen normal.
Die Lebensmittel trocknen aus	Die Lebensmittel sind nicht verpackt oder abgedeckt.	Die Lebensmittel verpacken oder in luftdichten Behältern verschließen.
Geruchsbildung im Innern	Irgendein Lebensmittel ist nicht ausreichend verpackt oder abgedeckt.	Verpacken oder in luftdichten Behälter verschließen.
	Das Innere des Geräts muß gereinigt werden.	Gemäß den entsprechenden Angaben dieser Bedienungsanleitung reinigen.

## TECHNISCHER KUNDENDIENST

Wenn Sie alle oben genannten Punkte überprüft haben, und die Störung weiterhin besteht, NICHT SELBSTÄNDIG EINE REPARATUR DURCHFÜHREN.

Setzen Sie sich mit Ihrem nächsten Kundendienst in Verbindung.

## TECHSNICHE DATEN

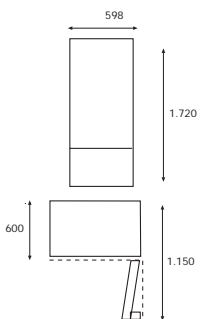
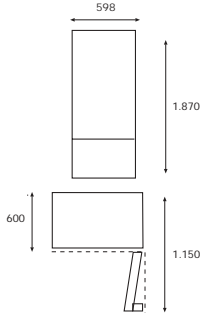
<p>• Abmessungen (mm.)</p>		
----------------------------	---	---



ALLE DIESE GERÄTE ERFÜLLEN DIE VERORDNUNGEN  
DER CEE: 73/23, 93/68, 89/336, 96/57

QUELFRIGO.COM

# INDICE

	Pag.
Installazione .....	2
Descrizione generale .....	3
Messa in funzionamento .....	4
Utilizzazione del frigorifero .....	5
Utilizzazione del congelatore .....	7
Pulizia e manutenzione .....	11
Cambio di senso d'apertura delle porte .....	12
Pannelazione (Solo modelli P e PB) .....	14
Problemi di funzionamento .....	15
Specificazioni .....	16

## AVVERTENZA

Se il suo vecchio frigorifero dispone di chiavistelli di chiusura automatica o manuale, **NON TRALASCI DI DISTRUGGERE O INUTILIZZARE IL SISTEMA DI CHIUSURA** prima di inviarlo alla demolizione. In questo modo eviterà che i bambini giocando possano rimanere chiusi dentro.

**NON DANNEGGI LE TUBATURE** ed eviterà la fuga incontrollata all'atmosfera del refrigerante.

## SICUREZZA:

• Il modello di frigorifero che Lei ha acquistato viene commercializzato con i refrigeranti R600a o R134a.

Lo può verificare guardando nella placca delle caratteristiche e, se il frigorifero utilizza R600a deve considerare che:

- Questo refrigerante non deteriora l'ambiente.
- È infiammabile, per cui si assicuri che il circuito frigorifero è in perfette condizioni. Se ha subito qualche danno, consultare con il distributore prima di connettere.
- Questo apparecchio può essere riparato unicamente dal servizio di assistenza tecnica ed utilizzando ricambi originali.
- Non utilizzare elementi con fuoco né apparecchi elettrici nell'apparecchio.
- Non lasciare che i bambini giochino con l'apparecchio.
- Evitare che il cavo sia in contatto con il compressore.
- Evitare che il cavo rimanga preso sotto l'apparecchio.
- Per evitare danni all'ambiente e recuperare materiali, utilizzi il servizio di raccolta municipale.



# INSTALLAZIONE

## RACCOMANDAZIONI

Permettere la circolazione d'aria nella parte posteriore del frigorifero.

Non tamponare la griglia davanti né sulla parte superiore del frigorifero con nessun oggetto. Se s'installa un armadio sopra, si lascerà un vano perchè circoli l'aria.

La classe climatica del suo frigorifero è indicata nella placca delle caratteristiche.

Questa determina la gamma di temperature ambiente per cui è disegnata l'unità frigorifera e con le quali si assicura il corretto funzionamento dell'apparecchio. Quando vengono indicate le due classi, si assicura il corretto unzionamento nelle condizioni di ciascuna di esse.

Classe	Temperature ambiente
N	16° fino 32°
ST	18° fino 38°
T	18° fino 43°

Evitare per tutto quanto possibile la vicinanza di fonti di calore.

Se ha necessità di disporre orizzontalmente il frigorifero per disimballarlo o per cambiare il senso d'apertura delle porte SI PUÒ STENDERLO APPOGGIANDOLO SOLAMENTE SULLA PARTE POSTERIORE.

NOTA: Le cerniere delle porte si trovano nel lato destro. Se questa disposizione non è comoda per lei, è possibile cambiare il lato delle cerniere. Nell'annesso si trovano le istruzioni.

Regolando i piedi di livellamento, controllare che il frigorifero sia appoggiato bene sul pavimento (senza zoppicare e ben livellato (non in pendenza). **IMPORTANTE.**

Questo frigorifero funziona a 220/230v. Se lei ha una tensione diversa nella sua casa, deve utilizzare un trasformatore di potenza non inferiore a 500 W.

Utilizzi una spina con PRESA DI TERRA.

NOTA: Il fabbricante non assume nessuna responsabilità nel caso che non si seguano queste raccomandazione.

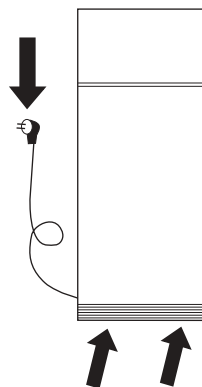
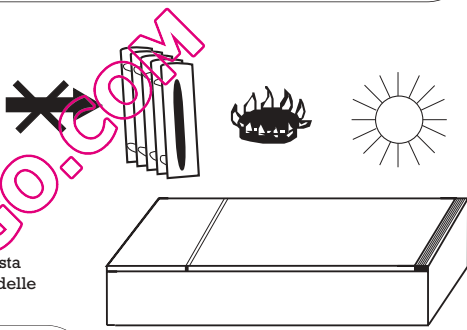

## ATTENZIONE PRIMA CONNETTERE

1.- Pulire l'interno del frigorifero.



2.- Per un funzionamento corretto, aspettare due ore prima di connettere.



3.- Connettere.



# DESCRIZIONE GENERALE

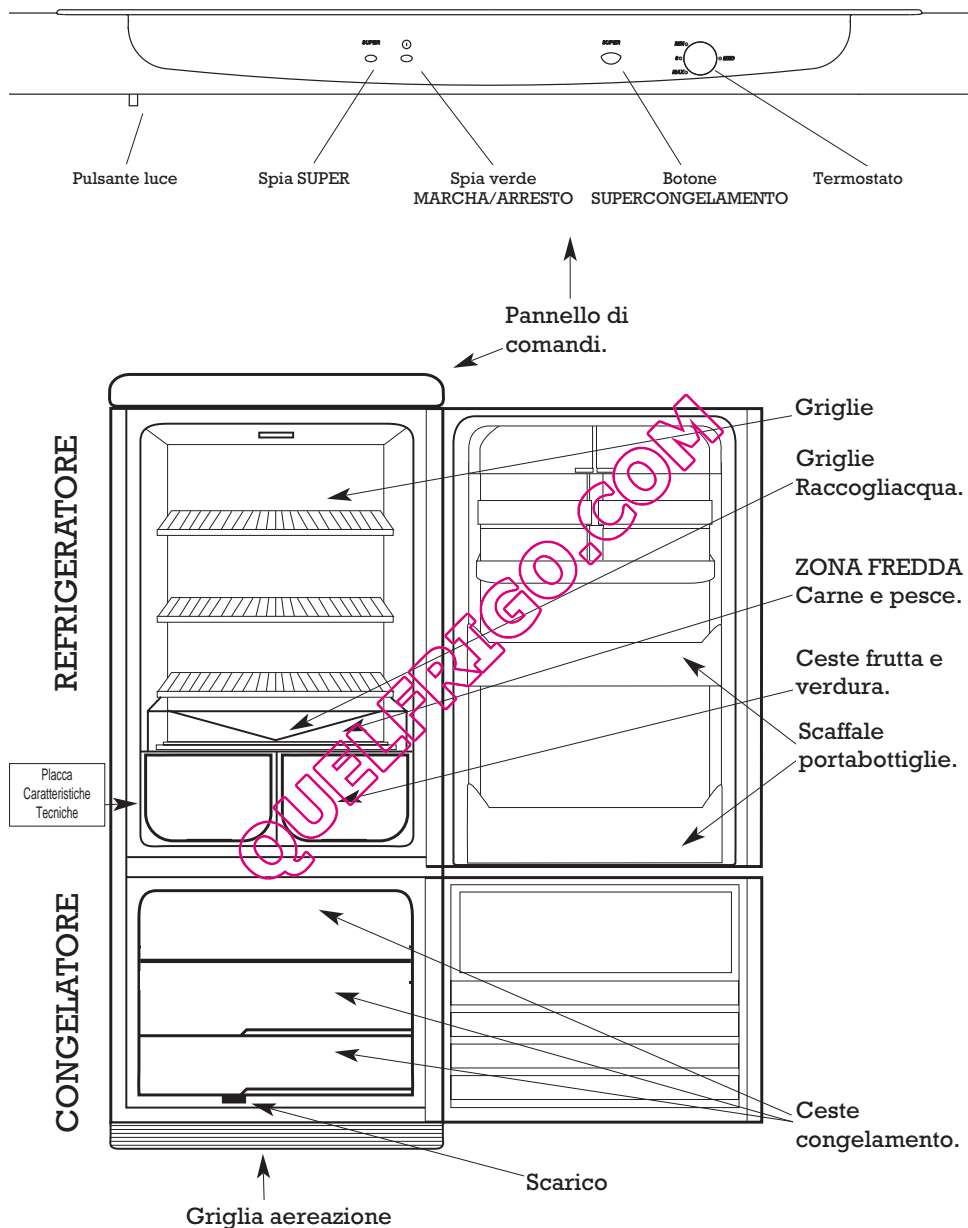

# MESSA IN FUNZIONAMENTO

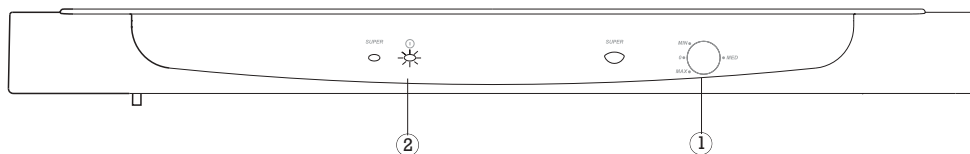

**1**

Girando il comando del termostato ① nel senso orario, la spia ② si accenderà ed il frigorifero si metterà in moto.



**2**

Girando il comando termostato, selezioni più freddo (MAX) o meno freddo (MIN) nel refrigeratore. Inizialmente si raccomanda di portare ad una posizione intermedia.



# UTILIZZAZIONE DEL REFRIGERATORE

## ALIMENTI

ZONA MENO FREDDA

ZONA INTERMEDIA

ZONA PIÙ FREDDA

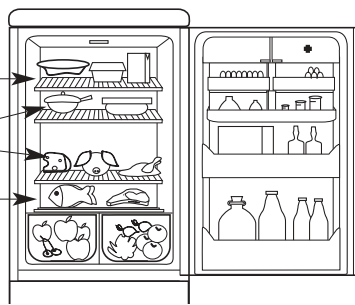

## ATTENZIONE

- Girando il comando termostato si può selezionare più o meno freddo nel frigorifero.
- Bisogna tener conto del fatto che la temperatura non è totalmente uniforme in tutto il recinto, per cui ci sono zone adeguate per ogni tipo di alimento (secondo la figura).
- La temperatura nel frigorifero può risentire della temperatura ambiente, dell'ubicazione dell'apparato e della frequenza d'apertura della porta.
- Non introdurre nel frigorifero alimenti caldi o liquidi senza tamponare.
- Non introdurre MAI liquidi volatili, infiammabili o esplosivi, come solventi, alcool, acetone, o benzina. C'è il rischio d'esplosione.
- È conveniente avvolgere la carne ed il pesce per evitare cattivi odori.

## SISTEMA MULTIFRESH

Se il suo frigorifero dispone di un vano Multifresh:

- Questo garantisce una **conservazione ideale** per alimenti freschi come carne e pesce ed anche per ortaggi. Questo le permetterà di conservare questi alimenti durante più tempo senza la necessità di congelarli.
- In questo senso si disporranno delle **temperature più fredde** del frigorifero, essendo inoltre la zona meno influenzata per le frequenti aperture.
- Per mantenere **carne e pesce**, si raccomanda di selezionare una temperatura intermedia nel frigorifero.
- Per ottenere una **maggior capacità** nel frigorifero ritiri il vassoio superiore ed il coperchio. Immagazzinando direttamente sulla vaschetta. In questo caso il vano multifresh perde le proprietà indicate.



# UTILIZZAZIONE DEL REFRIGERATORE

## SCONGELAMENTO

Il sistema di scongelamento del refrigeratore funziona automaticamente, pertanto non necessita nessun intervento dell'utente.

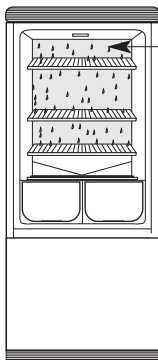

La parete del fondo del refrigeratore sarà abitualmente piena di gocce d'acqua o di ghiaccio. Questo è totalmente **NORMALE** e fa parte del processo automatico di scongelamento.

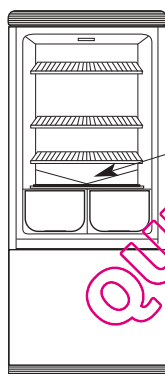

Se il canale raccogliacqua s'ingorga per la sporcizia o per qualche oggetto che lo ostruisca, lo pulisca. Eviterà in questo modo lo spargimento di acqua fuori dal canale raccogliacqua.

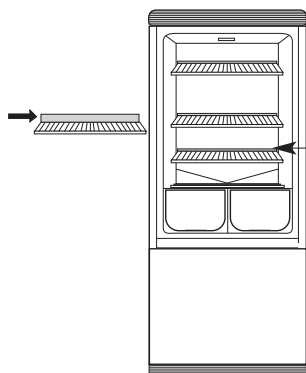

Faccia in modo che gli alimenti non tocchino la parete del fondo. Per questo le griglie dispongono di un limite che non deve essere superato.



# UTILIZZAZIONE DEL CONGELATORE

## CONGELAZIONE ALIMENTI FRESCI

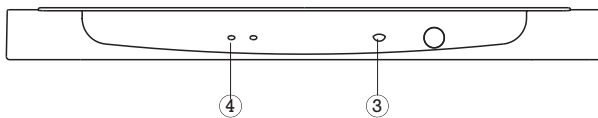

- 1** Introduca gli alimenti da congelare nel congelatore.

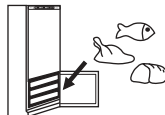

- 2** Prema il bottone di supercongelamento ③ (SUPER). La spia ④ si accenderà.



- 3** 24 ore più tardi prema di nuovo il bottone ③ sconnettendolo. La spia ④ si spegnerà. I suoi alimenti saranno perfettamente congelati.



## NOTA

- Il congelatore di questo frigorifero ha la categoria **\* \*\*\* 4** stelle in qualunque delle sue ceste ed è capace di congelare in 24 ore i kg. indicati nella placca delle caratteristiche.
- "Se Lei desidera congelare in una sola volta una quantità considerevole di alimenti, otterrà una miglior congelazione premendo il bottone di congelazione rapida 24 ore prima, ottenendo in questo modo la manutenzione delle temperature adeguate nel refrigeratore, evitando che si raffreddi in eccesso".

## CONSIGLI

- Avvolga i prodotti da congelare in carta d'alluminio o in recipienti ermetici.
- Prepari gli alimenti in porzioni consumabili un sola volta.
- Non congeli mai una seconda volta un alimento scongelato.
- Collochi un'etichetta sull'involucro indicando il contenuto e la data di congelamento.
- Non metta gli alimenti da congelare a contatto diretto con quelli già congelati.
- Non immagazzini nel congelatore bevande gassose.
- I gelati non devono essere consumati troppo freddi.

# UTILIZZAZIONE DEL CONGELATORE

## CONSERVAZIONE DEI CIBI CONGELATI

### CONSIGLI

- Quando acquisisce cibi congelati nei negozi, cerchi di far trascorrere meno tempo possibile fino alla loro introduzione nel congelatore.
- Faccia attenzione al tempo di conservazione riportato nelle confezioni dei prodotti congelati, tenendo presente che questo congelatore è di categoria **\* \*\***.
- Per i cibi da Lei congelati, consulti la tavola del tempo di conservazione.

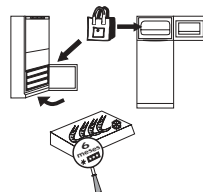

### TEMPO DI CONSERVAZIONE

TIPO DI CIBI	Numero Mesi
<b>PESCI E FRUTTI DI MARE</b>	
Aragoste-crostacei	3
Gamberetti-Ganberi	3
Merluzzo	2
Pesce grasso	3/4
Trote	2/3
Salmoni	2/3
Sogliole	3
Rombi	2/3
<b>CARNE</b>	
Vaccino maggiore	10/12
Agnello	6/8
Vitello	9
Maiale	6
Bistecche/costolette	4
Fegato/reni	10
Cervella/lingua	2
Carne trita, salsice	2
Coniglio	5/7
<b>GALLINACEI E CACCIA</b>	
Galline-pollai	10
Taccino (a pezzi)	7
Anitra, oca domestica e selvatica	5
Lepri	6
Pernici-quaglie	8
Fagiani	7/8
Caccia maggiore	10
<b>PIATTI PREPARATI</b>	
Salsa di pomodori	3
Brodo di carne	3
Arrosti, bue, vitello, pollo, maiale	2/3
Minestra di verdure	3
Carne lessa, stufato	3
Amburger	2
Peperoni ripieni	2
Spinaci	2
Fagiolini verdi e soffritti	2
Torte, pasticci, ecc	5/6
Macedonia di frutta	3
Sandwich	6

TIPO DI CIBI	Numero Mesi
<b>ORTAGGI</b>	
Coste	12
Carciofi	12
Carote	12
Cavolfiori	6/8
Cavolini di brusela	6
Asparagi	12
Verza	6/8
Fagiolini	12
Funghi a cappello	6
Prezzemolo	12
Peperoni	12
Spinaci	12
Fave	12
<b>FRUTTA</b>	
Albicocche	8
Ciliege, prugne, lamponi, ribes, more	10
Pesche	10/12
Fragole	12
Composta (mele e pere)	10
Uva	10/12
Succhi di frutta	10
Ananas	10/12
<b>PANE E PASTICCERIA</b>	
Trancio-Torte	6
Torta a sfoglia	1
Pasta da pasticceria	3
Pane e focaccine	2
<b>UOVA, LATTE E DERIVATI</b>	
Uova (senza guscio)	6
Latte omogeneizzato (confezione di cartone)	3
Burro	6
Formaggi (piccole porzioni)	6/8
Panna fresca	3

# UTILIZZAZIONE DEL CONGELATORE

## SCONGELAZIONE DEGLI ALIMENTI

Non tutti alimenti devono essere scongelati nello stesso modo.

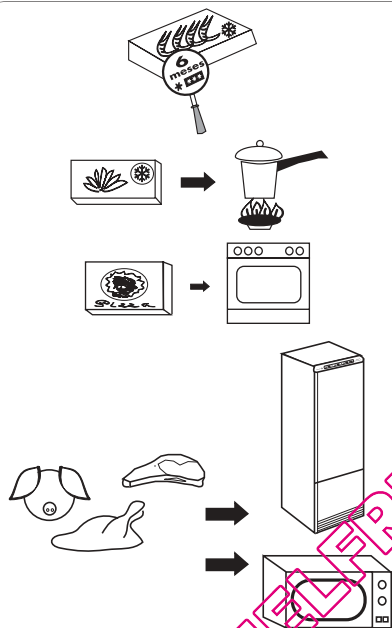

Se acquisti l'alimento congelato in commercio, segua le istruzioni del recipiente.

Le verdure devono essere cucinate direttamente.

In generale gli alimenti preparati o precotti possono essere cucinati direttamente.

Le carni ed il pesce devono essere scongelati lentamente nel refrigeratore per varie ore. Se dispone di forno microonda potrà accelerare in gran misura la scongelazione.

## PRODUZIONE DI CUBETTI DI GHIACCIO

- 1** Riempia fino a tre quarti d'acqua i vassoi che troverà nell'interno del congelatore.



- 2** Introduca i vassoi nel congelatore, preferibilmente nella parte superiore.

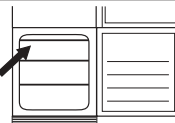

- 3** Dopo aver congelato l'acqua, può staccare i cubetti torcendo leggermente i vassoi.



# UTILIZZAZIONE DEL CONGELATORE

## SCONGELAMENTO E PULIZIA

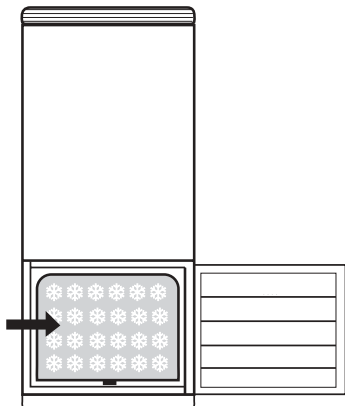

Con il tempo, sulle pareti del congelatore, si forma uno strato di brina o ghiaccio. Questo provocherà un maggior consumo di energia nel suo frigorifero. Per evitarlo, bisogna eliminare questo strato di ghiaccio, perlomeno 2 volte all'anno.

1

Girando il comando del termostato in senso antiorario, si spegnerà la spia ed il frigorifero verrà sconnesso.

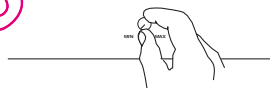

2

Ritiri gli alimenti congelati, li avvolgi in carta di giornale e li introduca nel refrigeratore, giacchè un eccessivo aumento della temperatura degli alimenti potrebbe diminuire la loro durata.



3

Lasciare la porta aperta ed aprire la linguetta elastica incastrata nella base del congelatore. Collocare sotto qualunque dei cestoni, eccetto quello inferiore, per raccogliere l'acqua. Terminata l'operazione collocare la linguetta nella posizione iniziale.

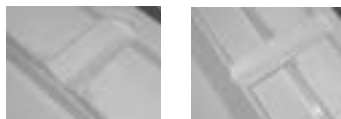

4

Può aiutare a eliminare il ghiaccio con una paletta o introducendo un recipiente con acqua calda. Non utilizzi oggetti affilati né apparati elettrici di riscaldamento,

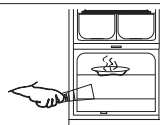

5

Asciughi bene l'interno

6

Giri il comando del termostato nel senso orario, si accenderà la spia ed il frigorifero verrà connesso.

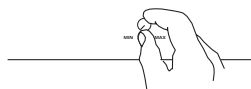

7

2 ore più tardi può ritornare a introdurre gli alimenti congelati nel congelatore.



# PULIZIA E MANUTENZIONE

## PULIZIA

### CONSIGLI

Per la pulizia dell'interno, il frigorifero deve essere sconnesso.

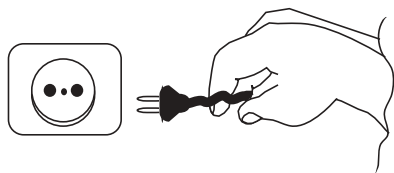

Non utilizzi prodotti abrasivi solventi, pulitori di metalli o detersivi non diluiti.

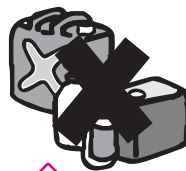

Eviti di spargere acqua sulla superficie superiore esterna o di pulirla con panni eccessivamente umidi. Potrebbe danneggiare il frigorifero.

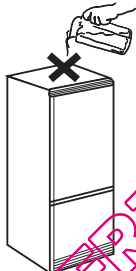

È conveniente pulire una volta all'anno con un aspirapolvere la griglia della parte posteriore del frigorifero. La sporcizia pregiudica il funzionamento ed aumenta il consumo di energia elettrica.

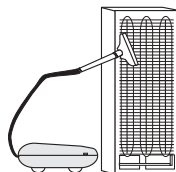

## SCONNESSIONE TEMPORANEA DEL FRIGORIFERO

- Sconnetta il frigorifero.
- Estragga gli alimenti, pulisca e asciughi l'interno.
- Lasci aperta la porta per evitare la formazione di cattivi odori.
- Faccia lo stesso in caso di interruzione di corrente prolungata o di averia del frigorifero.

## CAMBIO DI LAMPADA

1- Sconnettere il frigorifero.



2- Estrarre la lampada bruciata e sostituirla con un'altra dello stesso tipo.



220 v  
15 w max.

## CAMBIO DI SENSO DELL' APERTURA DELLE PORTE

1

Estragga la carcassa del pannello dei comandi introducendo la punta di un cacciavite nelle scanalature di fissaggio, facendo leva per liberare gli estremi.

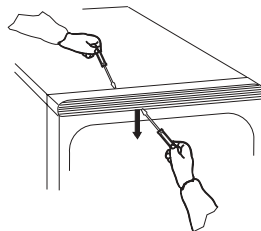

2

Estragga la cerniera superiore allentando previamente la vite di sostegno. Sorregga la porta superiore con entrambi le mani e la stacchi dal frigorifero.

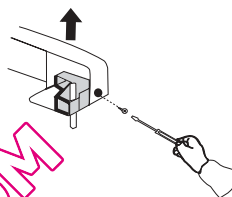

3

Estragga la cerniera intermedia ritirando la placchetta di protezione che occulta le viti e staccandole sorregga la porta inferiore con entrambi le mani e la stacchi dal frigorifero.

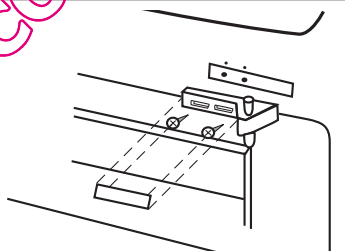

4

Estragga lo zoccolo inferiore così come viene indicato nella figura. Stacchi poi la parte sinistra marcata dello zoccolo per alloggiare la cerniera inferiore secondo la figura.

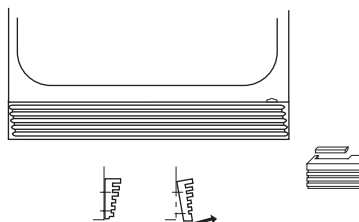

5

Estragga la cerniera inferiore allentando le tre viti di sostegno (A). Stacchi l'asse (B) dalla posizione destra e lo monti nella posizione sinistra della cerniera. Introduca la cerniera inferiore nel laterale sinistro allentando previamente le due viti (C).

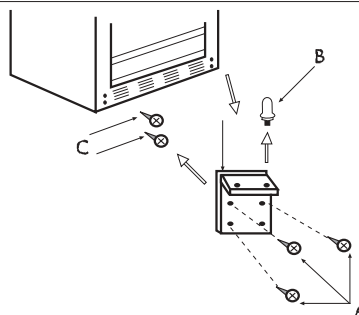

## CAMBIO DI SENSO DELL' APERTURA DELLE PORTE

Collochi di nuovo lo zoccolo inferiore nella sua posizione.

- 6 Collochi la porta inferiore introducendola nell'asse della cerniera inferiore

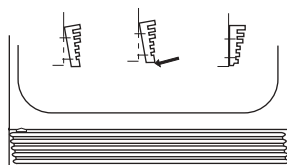

Stacchi il tappo dell'asse sinistro della porta inferiore e lo collochi nell'asse destro (i modelli pannellabili non hanno questo tappo).

7

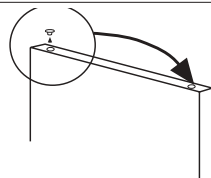

Introduca la cerniera intermedia nell'asse sinistro della porta inferiore e la avviti al frigorifero, staccando previamente il protettore dei fori.

- 8 Collochi la parte superiore introducendola nell'asse della cerniera intermedia. In seguito disporre la plachetta di protezione, che occulta le viti di fissaggio.

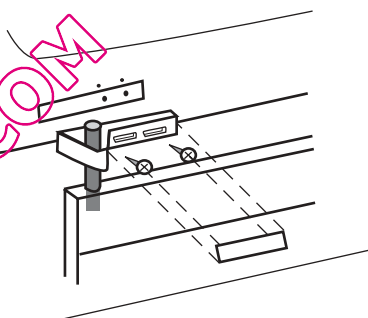

Introduca la cerniera nella sua sede della parte sinistra del pannello dei comandi e nell'asse della porta superiore simultaneamente. Sostenga la cerniera con la vite laterale.

9

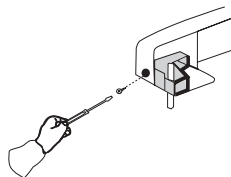

Introduca la carcassa del pannello dei comandi facendo pressione sul supporto fino a agganciare gli estremi di sostegno.

10

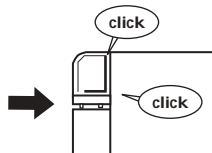

Se il frigorifero è pannellabile dovrà cambiare il lato dei tiranti delle porte.

11

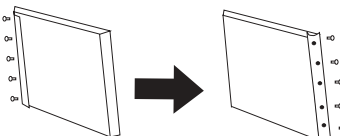

## PANNELLAZIONE

Se il suo frigorifero è un modello pannellabile e desidera che l'aspetto esterno del suo frigorifero assomigli al resto della mobilia della sua cucina, può rivestire le porte con pannelli seguendo queste istruzioni.

- 1** Dimensioni del mobile frigorifero e del pannello delle porte  
(Spessore dei pannelli minore di 4 mm).

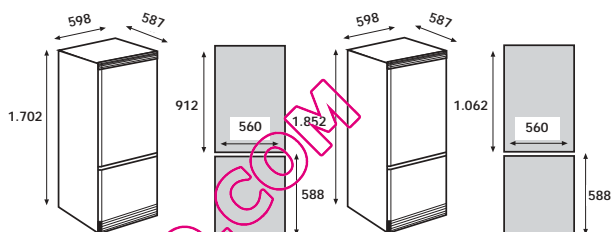

- 2** Estragga la maniglia e/o la cornice del lato sinistro della porta allentando le viti corrispondenti.

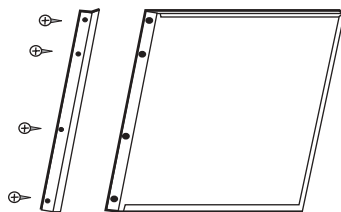

- 3** Allenti il resto delle viti del contorno della porta estraendo le cornici come indica la figura e introduca il pannello spostandolo.

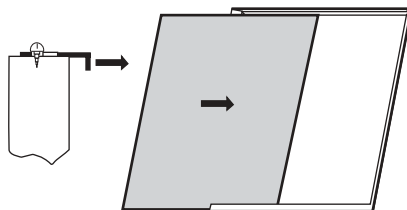

- 4** Stringa il bordo della cornice contro il pannello e sostenga le viti della cornice in tale posizione. Collochi la cornice e/o la maniglia con le loro viti.

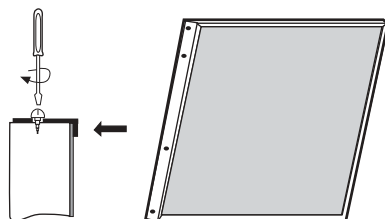



# PROBLEMI DI FUNZIONAMENTO

PROBLEMA	CAUSA POSSIBILE	SOLUZIONE
Il frigorifero non funziona	La presa non è connessa alla presa di corrente.	Connettere presa.
	La corrente elettrica non raggiunge la presa essendosi fuso il fusibile o essendo saltato il limitatore automatico di potenza.	Cambiare il fusibile o riconnettere il limitatore automatico di potenza.
Il refrigeratore raffredda poco	Il comando del termostato si trova in una posizione bassa.	Giri il comando termostato a una posizione superiore di freddo.
	La porta è stata chiusa male o si è aperta con molta frequenza.	Aver cura che la porta non rimanga aperta per molto tempo.
	Si è otturata la griglia d'aerazione o l'apertura della parte posteriore della parte superiore.	Conservare libere queste zone secondo quanto viene indicato nel capitolo "Installazione" di questo manuale.
	Il frigorifero è spostato direttamente ai raggi del sole o a una fonte di calore.	Cambiare l'ubicazione del frigorifero o proteggerlo da queste fonti di calore.
Gocce d'acqua nella parete del fondo del refrigeratore	Ciclo automatico di scongelamento.	Non si allarmi: questo è completamente normale (vedere capitolo "Utilizzazione del refrigeratore" di questo manuale).
Si vede acqua nella base del refrigeratore	Si è collocato qualche alimento o recipiente attaccato alla parete del fondo del refrigeratore.	Non collochi alimenti o recipienti a contatto con la parete del fondo ed eviterà lo spargimento dell'acqua di scongelamento.
	Lo scarico del refrigeratore è ostruito.	Disotturi lo scarico, secondo quanto viene indicato nel capitolo "Utilizzazione del refrigeratore" di questo manuale.
Molto ghiaccio nelle pareti e negli scaffali del congelatore	La porta congelatore non chiude bene essendo ostacolata.	Cerchi una buona chiusura delle porte mantenendole libere da oggetti o sporcizia.
La lampada del refrigeratore non si accende	La presa non è connessa alla presa di corrente.	Connettere la presa.
	Non giunge corrente elettrica alla presa essendosi fuso il fusibile o essendo saltato il limitatore automatico di potenza.	Cambiare il fusibile o ritornare a connettere il limitatore automatico di potenza.
	La lampada è lenta.	Avvitare correttamente.
	La lampada è fusa.	Cambiare la lampada secondo quanto viene indicato in questo manuale.
Funzionamento rumoroso	Il frigorifero non è stato livellato correttamente.	Livellare secondo quanto viene indicato nel capitolo "Installazione" di questo manuale.
Gorgoglio	Ciclo funzionamento.	Non si allarmi, questo è completamente normale.
Gli alimenti si seccano	Gli alimenti non sono avvolti o tappati.	Avvolgerli o introdurlo in recipienti ermetici.
Odori nell'interno	Qualche alimento non è correttamente avvolto o tappato.	Avvolgerlo o introdurlo in un recipiente ermetico.
	L'interno dell'apparato necessita una pulizia.	Pulire secondo quanto viene indicato in questo manuale.

## SERVIZIO DI ASSISTENZA TECNICA

Se lei ha già effettuato i controlli indicati ed il suo problema persiste, **NON REALIZZI NESSUN'ALTRA RIPARAZIONE PER PROPRIO CONTO.**

Si metta a contatto con il servizio d'Assistenza Tecnica più vicino.

## SPECIFICAZIONI

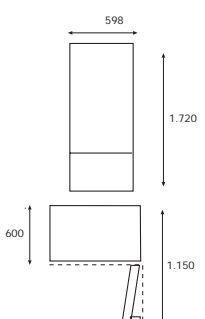
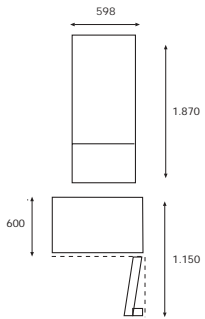
<p>• Dimensioni (in mm)</p>		
-----------------------------	---	---

CE

QUESTI APPARECCHI SODDISFANO I REQUISITI DELLE  
DIRETTIVE CEE: 73/23, 93/68, 89/336, 96/57

QUELFRIGO.COM

QUELFRIGO.COM



QUELFRIGO.COM